

Use of traps

Most of the currently used traps used for mammals can be divided into five types: foothold traps, body gripping traps, snares, cages, and glue traps.

Foothold traps []



 A journal entry featuring photographs of wolves in traps by Vernon Orlando Bailey, 1909-1918

Probably most commonly associated with trapping, the foothold trap is made up of two jaws, one or more springs, and a trigger in the middle which is usually a round pan. When the animal steps on the trigger the trap closes around the foot, preventing the animal from escaping. Usually some kind of lure is used to position the animal, or the trap is set on an animal trail. Foothold traps set for beaver, mink, river otter, and muskkrat are positioned in shallow water along the shores and banks of rivers, lakes and ponds. Sometimes the trap is attached to a weight sunk in deeper water. The animal, when caught by the foot, tries to escape by diving into deep water and drowns. Traditionally, these traps had tightly closing jaws to make sure the animal stayed in place. These traps are made in various sizes depending on the size of the intended quarry. At one time traps for wolves had rounded teeth on the jaws to prevent escape.

Modified traps are now available with offset jaws, or lamination, or both, which decrease pressure on the animals' legs. Traps are also available with a padded jaw, which has rubber inserts inside the jaws to reduce animal injuries.^[14] However these traps may be more expensive. A single number 3 foothold trap which has a 6 inch jaw spread and commonly used for trapping beaver and coyote costs about 10 to 20 dollars depending on the make, while a padded jaw or "Soft Catch" trap may cost from 12 to 20 dollars.^[15] Today's traps are specially designed in different sizes for different sized animals, which reduces injuries.^[16] Anti-fur campaigns have protested leghold traps on the grounds that an animal caught in a leghold trap will frequently chew off its leg to escape the trap,^[17] while the National Animal Interest Alliance states that modern foothold traps have been designed to hold animals as humanely as possible to reduce incidences of the animal fighting the trap, possibly injuring itself or getting loose in the process.^[18]

In states that have banned the use of the foothold trap, a number of issues have arisen. In Massachusetts, the beaver population increased from 24,000 in 1996 to over 70,000 beaver in 2001.^[19] Coyote attacks on humans rose from 4 to 10 per year, during the five year period following a 1998 ban on leghold traps in Southern California.^[20]

Manufacturers of newer types of traps designed to work only on raccoons are referred to as dog-proof. These traps are small, and rely on the raccoon's grasping nature to trigger the trap. They are sold as coon cuffs, bandit busters and egg traps just to name a few.^[21]

Body gripping/conibear traps []



Conibear model 220 body-gripping trap, set.



Rat and mouse traps used for pest control

Body-gripping traps are designed to kill animals quickly. They are often called "Conibear" traps after Canadian inventor Frank Conibear who began their manufacture in the late 1950s as the Victor-Conibear trap.^[22] Many trappers consider these traps^[who?] to be one of the greatest trapping innovations of the 20th century; animals that are caught squarely on the neck are killed quickly, and are therefore not left to suffer or given a chance to escape.

The general category of body-gripping traps may include snap-type mouse and rat traps, but the term is more often used to refer to the larger, all-steel traps that are used to catch fur-bearing animals. These larger traps are made from bent round steel bars. These traps come in several sizes including model #110 or #120 at about 5 by 5 inches (130 by 130 mm) for muskrat and mink, model #220 at about 7 by 7 inches (180 by 180 mm) for raccoon and possum, and model #330 at about 10 by 10 inches (250 by 250 mm) for beaver and otter.

An animal may be lured into a body-gripping trap with bait, or the trap may be placed on an animal path to catch the animal as it passes. In any case, it is important that the animal is guided into the correct position before the trap is triggered. The standard trigger is a pair of wires that extend between the jaws of the set trap. The wires may be bent into various shapes, depending on the size and behavior of the target animal. Modified triggers include pans and bait sticks. The trap is designed to close on the neck and/or torso of an animal. When it closes on the neck, it closes the trachea and the blood vessels to the brain, and often fractures the spinal column; the animal loses consciousness within a few minutes and dies soon thereafter. If it closes on the foot, leg, snout, or other part of an animal, the results are less predictable.

Trapping ethics call for precautions to avoid the accidental killing of non-target species (including domestic animals) by body-gripping traps.^{[23][24]}

Deadfall traps []

A *deadfall* is a heavy rock or log that is tilted on an angle and held up with sections of branches (sticks), with one of them that serves as a trigger. When the animal moves the trigger which may have bait on or near it, the rock or log falls, crushing the animal. The figure-four deadfall is a popular and simple trap constructed from materials found in the bush (three sticks with notches cut into them^[clarification needed], plus a heavy rock or other heavy object). Also popular, and easier to set, is the Paiute deadfall, consisting of three long sticks, plus a much shorter stick, along with a cord or fiber material taken from the bush to interconnect the much shorter stick (sometimes called catch stick or trigger stick) with one of the longer sticks, plus a rock or other heavy object.^[25]

Snares []

Snares are anchored cable or wire nooses set to catch wild animals such as squirrels and rabbits.^[26] In the USA, they are most commonly used for capture and control of surplus furbearers, and, especially, for food collection. They are also widely used by subsistence and commercial hunters for bushmeat consumption and trade in African forest regions.^[27]

Snares are one of the simplest traps and are very effective.^[28] They are cheap to produce and easy to set in large numbers. A snare traps an animal around the neck or the body; a snare consists of a noose made usually by wire or a strong string. Snares are widely criticised by animal welfare groups for their alleged cruelty.^[29] UK users of snares accept that over 40% of animals caught in some environments will be non-target animals, although non-target captures range from 21% to 69% depending on the environment.^[30] In the USA, non-target catches reported by users of snares in Michigan were 17 +/- 3%.^[31]

Snares are regulated in many jurisdictions, but are illegal in other jurisdictions, such as in much of Europe. Different regulations apply to snares in those areas where they are legal. In Iowa, snares have to have a 'deer stop' which stops a snare from closing all the way. In the United Kingdom, snares must be 'free-running' so that they can relax once an animal stops pulling, thereby allowing the trapper to decide whether to harvest^{[32][33]} the animal or release it. Following a consultation on options to ban or regulate the use of snares,^[34] the Scottish Executive announced a series of measures on the use of snares, such as the compulsory fitting of safety stops, ID tags and marking areas where snaring takes place with signs.^[35] In some jurisdictions, swivels on snares are required, and dragging (non-fixed) anchors are prohibited.^{[36][37]}

Trapping pit []

Main article: Trapping pit

Trapping pits are deep pits dug into the ground, or built from stone, in order to trap animals. Like cage traps they are usually employed for catching animals without harming them.

Cage traps (live traps) []



📌 Bear trap at Großer Waldstein in Germany



📌 A British cage trap for small animals



📌 Cage trap with shade cloth to protect animal from heat.

Cage traps are designed to catch live animals in a cage. They are usually baited, sometimes with food bait and sometimes with a live "lure" animal. Common baits include cat food and fish. Cage traps usually have a trigger located in the back of the cage that causes a door to shut; some traps with two doors have a trigger in the middle of the cage that causes both doors to shut. In either type of cage, the closure of the doors and the falling of a lock mechanism prevents the animal from escaping by locking the door(s) shut.

Supporters of cage traps say that they are the most humane form of trapping, and in some countries are the only method of trapping allowed. Cage traps are used by animal control officers to catch unwanted animals and move them to another location without harm, as well as by gamekeepers to catch birds and animals they consider to be pests.

Cage traps are also sometimes used for capturing small animals such as squirrels by homeowners in attics or basements of homes, for removal to locations where they may either be legally killed and disposed of, or released unharmed. Some municipal jurisdictions specifically prohibit transporting live squirrels and releasing them into other areas to control the spread of diseases; for these jurisdictions, killing the squirrels within the cage quickly and humanely is the only legal and ethical means of disposing of them.

Cage traps are also used in muskrat trapping. A cage trap is set in a runway and the muskrat pushes the door open which is at a 45 degrees. Once the muskrat enters the cage trap the other side is closed with

another door at 45 degrees. So the muskrat drowns in the trap which is set under water. No bait is necessary, as the trap is set in a muskrat runway.

In the UK, cage traps are used to control corvids and such trapping is mainly carried out on game shooting estates. Large Ladder traps and smaller Larsen traps are used. ^[*further explanation needed*]

Large heavy-duty cage traps are also useful in catching large dangerous animals for transport and are a favourite of Australian crocodile trappers. Due to their bulk and cost, they are hard to set in great numbers or in remote locations. ^[*citation needed*]

Glue traps []



 Glue trap

Glue traps made using natural or synthetic adhesive applied to cardboard or similar material. Bait can be placed in the center or a scent may be added to the adhesive; alternatively, the traps may be placed in animal pathways. Glue board traps are used primarily for rodent control indoors. Glue traps are not effective outdoors because environmental conditions (moisture, dust) quickly make the adhesive ineffective. Glue traps are not used by animal trappers or fur trappers and are almost exclusively used by homeowners for rodent control. ^[*citation needed*]

Domestic animals accidentally captured in glue traps can be released by carefully applying cooking oil or baby oil to the contact areas and gently worked until the animal is free. Many animal rights groups, such as the Humane Society and In Defense of Animals, oppose the use of glue traps for their alleged cruelty to animals. ^{[38][39]}

Glue traps are typically not used for trapping birds, however a substance known as birdlime was used in the past in a similar manner to catch small birds; its use is banned now in most countries. ^[*citation needed*] The use of glue traps for catching birds is still prevalent in some countries such as Spain, in spite of being illegal. ^[*citation needed*] A sticky repellent can be applied to surfaces to temporarily repel perching birds from building ledges and statues. The adhesives registered for this use are classified as tactile repellents. ^[*citation needed*]

Unwanted catches []

Trappers can employ a variety of devices and strategies to avoid unwanted catches. Ideally, if a non-target animal (such as a bobcat, lynx, or domestic dog) is caught in a non-lethal trap, it can be released without harm. A careful choice of set and lure may help to catch target animals while avoiding non-target animals. Although trappers cannot always guarantee that unwanted animals won't be caught, they can take precautions to avoid unwanted catches or release them unharmed.

The snaring of non-target animals can be minimized using methods that exclude animals larger or smaller than the target animal. For example, deer stops are designed to avoid the snaring of deer or cattle by the leg; they are required in many States of the USA. Other precautions include setting snares at specific heights, diameters, and locations. In a study of foxes in the UK, researchers were unintentionally snaring brown hares about as frequently as the intended foxes until they improved their methods, using larger wire with rabbit stops to eliminate the unwanted catch of the brown hares.^[40]

Types of sets []

The most productive set for foothold traps is the dirt hole. The basic dirt hole is merely a hole dug in the ground with a trap positioned in front of the hole. An attractant is then placed inside the hole. The hole for the set is usually made in front of some type of object which is where medium-sized animals such as coyotes, fox or bobcats would use for themselves to store food. This object could be a tuft of taller grass, a stone, a stump, or some other natural object. The dirt from the hole is sifted over the trap and a lure applied around the hole.

A flat set is another common use of the foothold trap. It is very similar to the dirt hole trap set, simply with no hole to dig. The attractant is placed on the object near the trap and a urine scent sprayed to the object. The cubby set simulates a den in which a small animal would live, but could be adapted for larger game. It could be made from various materials such as rocks, logs or bark, but the back must be closed to control the animals approach. The bait and/or lure is placed in the back of the cubby.

The water set is usually described as a body-gripping trap or snare set so that the trap jaws or snare loop are partially submerged. The conibear is a type of trap used in water trapping and can also be used on land and is heavily regulated. The regulations vary from jurisdiction to jurisdiction. It is normally used without bait and has a wire trigger in the middle of its square-shaped, heavy-gauge wire jaws. It is placed in places that are frequented by the fur bearing animals.

How to Set -- and Release -- a Conibear Trap



Mountain and an old Conibear found at the entrance to a sette the dogs entered.

Let's begin with the most important thing: Conibear traps kill a lot of dogs and cats, and they can

take your fingers off.

To repeat: Conibear traps can easily kill a small dog and cat and maim you.

Read that again. Do it once more. Got it? Good!

Now for some knowledge. Did you know that Conibear traps were invented by the animal rights folks as an alternative to the far safer leghold trap?

True!

Conibear traps were first designed by Frank Conibear in the 1950s in Canada, and were the first substantive improvement in traps since the leghold trap was invented in 1823.

The development of this type of trap was paid for by an animal rights group, and the trap was designed to kill very fast. This sure-kill trap design was subsequently approved by the International Humane Society.

Ironically, because this type of trap kills almost instantly, and is very difficult to release even if you are standing right there when it fires off, this trap is a very serious threat to cats and small dogs which might otherwise be unharmed if entangled in a modern leghold trap or a snare.

In my opinion, a Conibear should only be used in a water set on muskrat (#110 Conibear) or beaver (#330 Conibear) or in a tree set for coon. If you are looking to get rid of a nuisance raccoon, consider a cuff-type trap (sometimes called an egg trap) as there is zero by-catch with these devices.

Having said my peace about Conibear traps, if you have a groundhog problem they are a very good fix, especially if the problem is in a location where there are no cats and small dogs around (do not presume -- *know*).

The right sized Conibear trap for groundhog is the same used on raccoon and fox -- a #220. The setup is described below, with the trap fixed to a stake right at the burrow entrance.

There is no cheaper source for traps than ebay; just make sure the things are not rusted, have good springs, etc.

A simple dirt den set, as shown above, is very easy with a Conibear, but *it is not as safe as it might be*.

To improve on safety for small dogs and cats, rig up a "bucket set" or "pipe set" as pictured below.

This is a simple #220 Conibear inside a square plastic bucket or PVC pipe, with slots for the the spring ears, as shown.



For groundhog, cut both ends off the bucket so that the groundhog has to exit his den through the bucket, with the trap close to the dirt side of the hole and dirt mounded up around it to keep the bucket in place, and the light out.

To see how the trap is set up in a round paint bucket (and how safety can further be improved by putting the bucket up a tree if you are trapping raccoon), [click here](#).

If you are trapping anything, you will need a trapping license and your traps need to be tagged, and there may be other restrictions as well, especially on Conibears. See your state wildlife agency or Department of Natural Resources web site for more details. *Do it right!*

Never trap near a road or path, never use bait with a ground set Conibear, and remember that barns and outbuildings attract cats as well as racoons and groundhogs.

Since we're about to enter trapping season, those who do not trap but who take dogs out into the woods should know how to get their dogs out of a trap if it comes to that. [Click here for simple instructions](#).

The previous link was cited by *The Anchorage Daily News* who went on to use it to develop the very nice graphic, below, on how to get your dog out of a Conibear trap. Remember, that if there are no safety catches on the trap itself (there generally are), your shoelaces are a tool that is always with you in the woods!

What to do if your dog is caught in a conibear trap

■ The trap

This is how the trap looks when it is set. The springs are compressed and safety catches released. The trigger and dog are set.

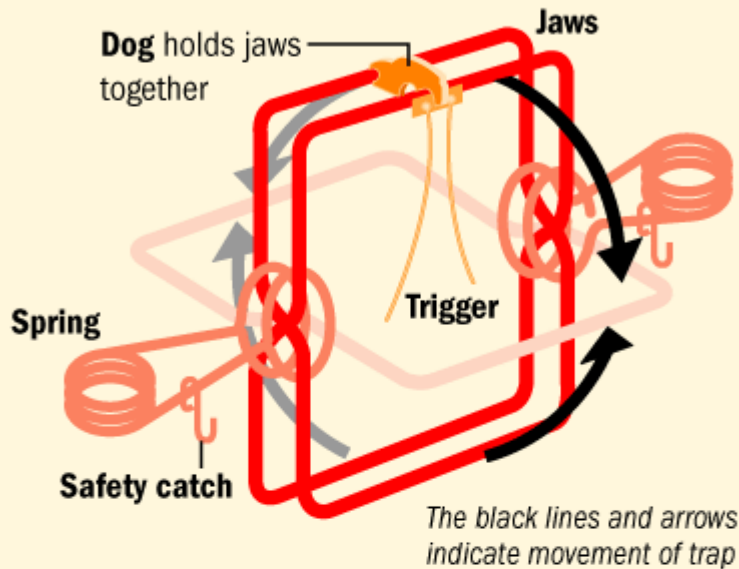

■ How it works

A animal trips the trigger, the springs decompress, jaws close with great force

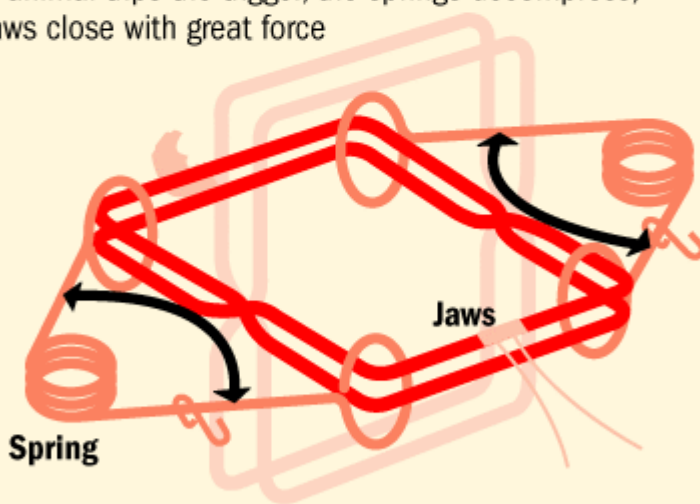

■ To release the trap

Don't try to pry the jaws apart, compress the springs, secure with safety catch



traps & snares

| | | |
|---------------------------------------|--------------------------|-----------------------|
| <u>The key to trapping</u> | <u>Twitch-Up Snare</u> | <u>Spring Snare</u> |
| <u>Baited Snare</u> | <u>Leg Snare</u> | <u>Platform Trap</u> |
| <u>Deadfall</u> | <u>Paiute Deadfall</u> | <u>Bow Trap</u> |
| <u>Pig Spear Shaft</u> | <u>Tripwire Deadfall</u> | <u>Spear Deadfall</u> |
| <u>Sprung Spear</u> | <u>Baited Hole Noose</u> | <u>Drag Noose</u> |
| <u>Squirrel Pole</u> | <u>Ojibwa Bird Pole</u> | <u>Bottle Trap</u> |
| <u>Noosing Wand</u> | <u>Snakes</u> | <u>Birds</u> |
| <u>Skinning & Butchering Game</u> | <u>Smoking Meat</u> | <u>Drying Meat</u> |
| <u>Other Preservation Methods</u> | <u>Freezing</u> | <u>Brine and Salt</u> |

The key to trapping

With most small game it is easier to trap than to stalk and kill, in a survival situation setting traps also leaves you with time to attend to other duties like foraging or shelter building. Your aim is to either tangle, dangle, strangle or mangle your quarry. Putting up several traps around your shelter/retreat gives you more than one opportunity at a time to catch a meal, check all traps regularly to prevent escape and undue suffering. Starting a routine of regularly doing the rounds of your traps will provide you with a positive activity, however BE PATIENT, you will need to study the habits of animals to site traps effectively more intelligent creatures will initially be wary of anything new but will quickly come to accept the presence of traps.....That's when they walk into them!

Twitch-Up Snare

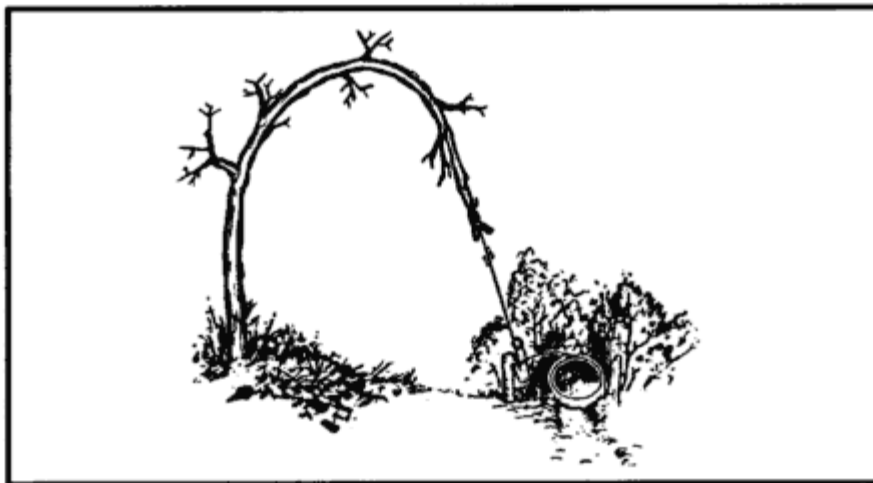

Figure 8-7. Twitch-up snare.

A simple twitch-up snare uses two forked sticks, each with a long and short leg. Bend the twitch-up and mark the trail below it. Drive the long leg of one forked stick firmly into the ground at that point. Ensure the cut on the short leg of this stick is parallel to the ground. Tie the long leg of the remaining forked stick to a piece of cordage secured to the twitch-up. Cut the short leg so that it catches on the short leg of the other forked stick. Extend a noose over the trail. Set the trap by bending the twitch-up and engaging the short legs of the forked sticks. When an animal catches its head in the noose, it pulls the forked sticks apart, allowing the twitch-up to spring up and hang the prey. Note: Do not use green sticks for the trigger. The sap that oozes out could glue them together.

Spring Snare



Game running through the snare disengages the trigger bar, and the prey is flung off the ground. Use on game trails or in gaps through rocks or hedges. Cut a notch in triggerbar (a) to fit upright (b). Drive upright into ground. Attach snare to trigger bar, then trigger bar to sapling.

Baited Snare



Construct as for spring snare but using the release mechanism shown. The bait support should be only lightly driven into the ground as it must fly away with the snare.

Leg Snare

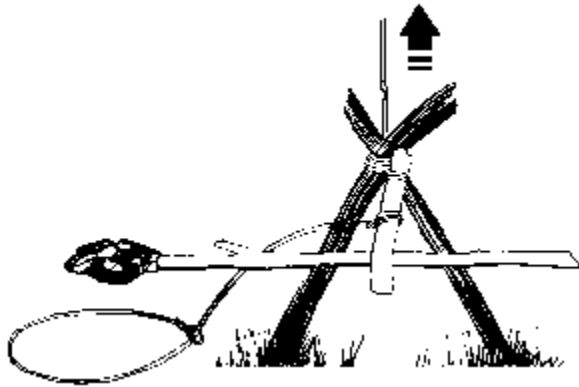

Push **FIRMLY** a natural fork or two sticks tied together into the ground. The line from a sapling is tied to a wooden toggle and the toggle passed under the fork. When the game takes the bait, attached to a separate stick, it falls away releasing the toggle which flies up taking the snare and the game with it. Large versions are amongst the best snares for heavy game.

Platform Trap

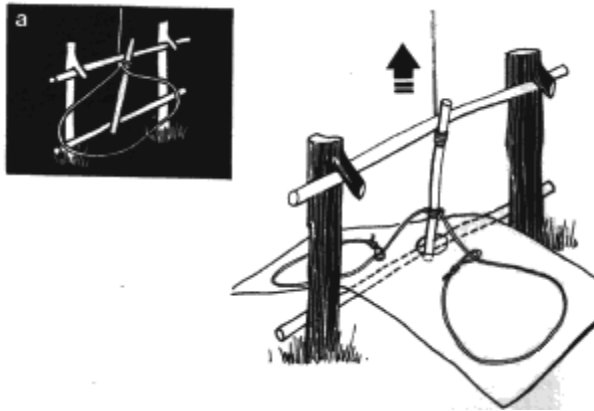

Site over a small depression on the game trail. Snares on the platforms either side, when the platform is depressed the trigger is released and the game held firmly by the leg. For smaller, lighter game use the mechanism shown in (a), displacing either the bottom bar or the toggle will trigger the trap.

Deadfall

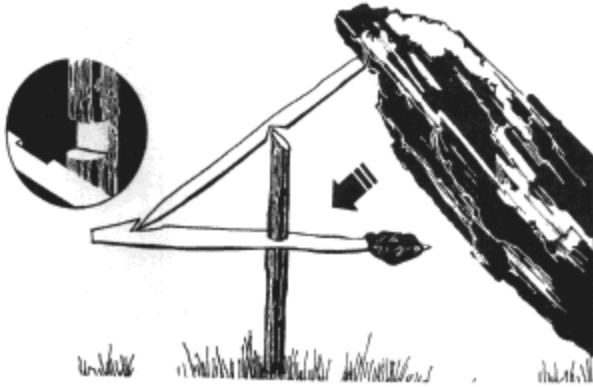

A simple and effective deadfall trap, can be made to any size. A horizontal bait bar is is balanced at right angles to an upright with a lock bar, which supports a rock or other heavy weight pivoting around the tip of the upright.

Paiute Deadfall

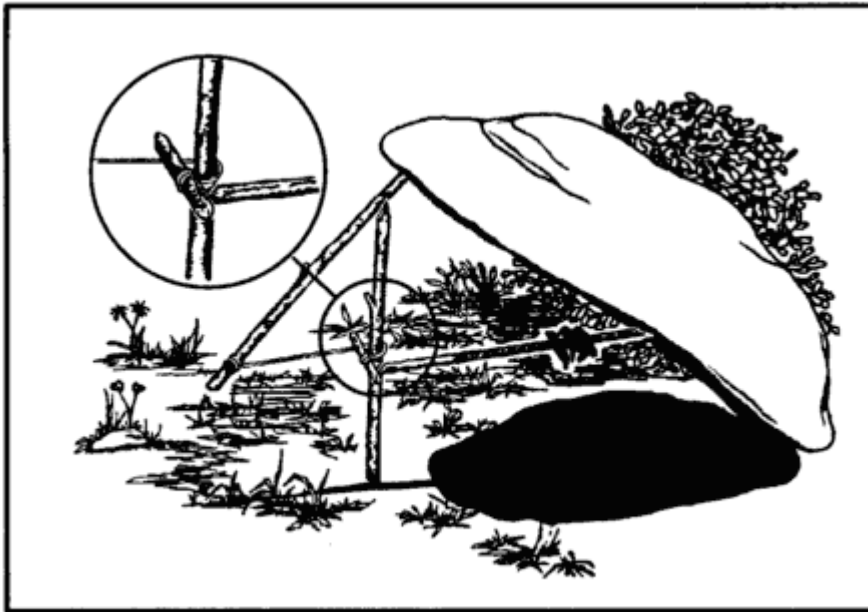

Figure 8-13. Paiute deadfall.

The Paiute deadfall is similar to the Deadfall, but uses a piece of cordage and a catch stick. It has the advantage of being easier to set than the normal Deadfall. Tie one end of a piece of cordage to the lower end of the diagonal stick. Tie the other end of the cordage to another stick about 5 centimeters long. This 5-centimeter stick is the catch stick. Bring the cord halfway around the vertical stick with the catch stick at a 90-degree angle. Place the bait stick with one end against the drop weight, or a peg driven into the ground, and the other against the catch stick. When a prey disturbs the bait stick, it falls free, releasing the catch stick. As the diagonal stick flies up, the weight falls, crushing the prey.

Bow Trap

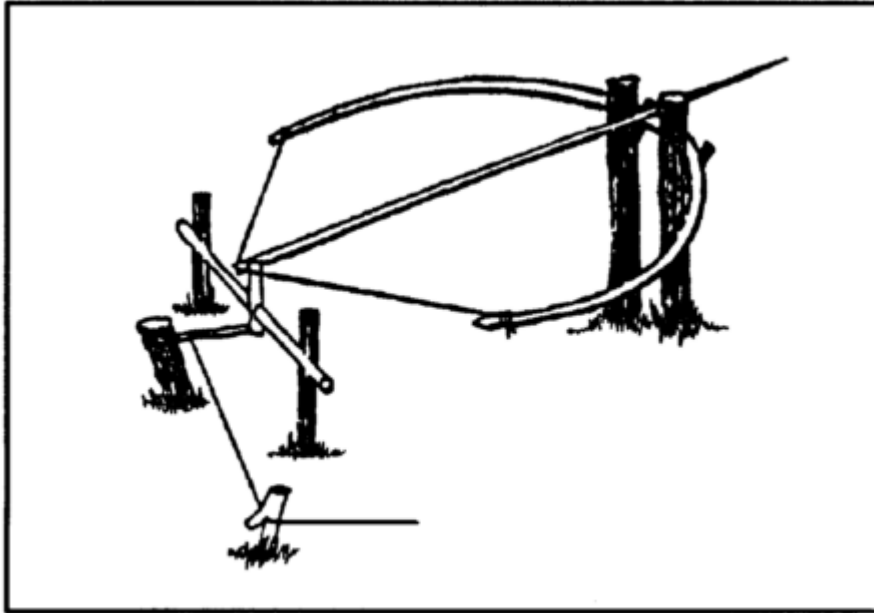

Figure 8-14. Bow trap.

A bow trap is one of the deadliest traps. It is dangerous to man as well as animals. To construct this trap, build a bow and anchor it to the ground with pegs. Adjust the aiming point as you anchor the bow. Lash a toggle stick to the trigger stick. Two upright sticks driven into the ground hold the trigger stick in place at a point where the toggle stick will engage the pulled bow string. Place a catch stick between the toggle stick and a stake driven into the ground. Tie a trip wire or cordage to the catch stick and route it around stakes and across the game trail where you tie it off. When the prey trips the trip wire, the bow loses an arrow into it. A notch in the bow serves to help aim the arrow. **WARNING** - This is a lethal trap. Approach it with caution and from the rear only!

Pig Spear Shaft

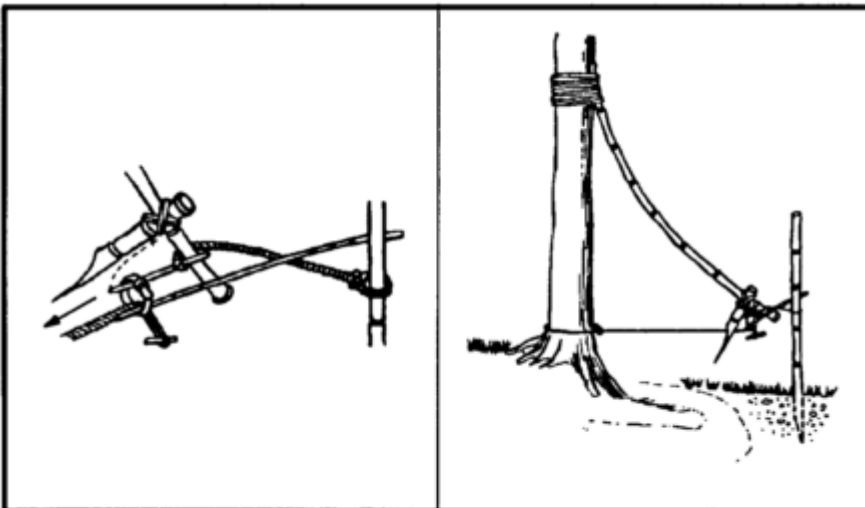
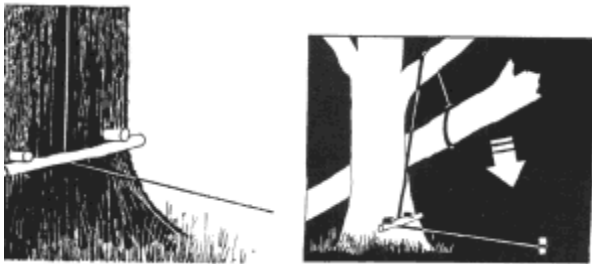

Figure 8-15. Pig spear shaft.

To construct the pig spear shaft, select a stout pole about 2.5 meters long. At the smaller end, firmly lash several small stakes. Lash the large end tightly to a tree along the game trail. Tie a length of cordage to another tree across the trail. Tie a sturdy, smooth stick to the other end of the cord. From the first tree, tie a trip wire or cord low to the ground, stretch it across the trail, and tie it to a catch stick. Make a slip ring from vines or other suitable material. Encircle the trip wire and the smooth stick with the slip ring. Emplace one end of another smooth stick within the slip ring and its other end against the second tree. Pull the smaller end of the spear shaft across the trail and position it between the short cord and the smooth stick. As the animal trips the trip wire, the catch stick pulls the slip ring off the smooth sticks, releasing the spear shaft that springs across the trail and impales the prey against the tree. **WARNING - This is a lethal trap. Approach it with caution!**

Tripwire Deadfall



A heavy log is suspended over a busy game trail, trips the wire and pulls a retaining bar from under two short pegs secured in a tree trunk. Keep the pegs as short as possible so that the bar will disengage easily.

Spear Deadfall

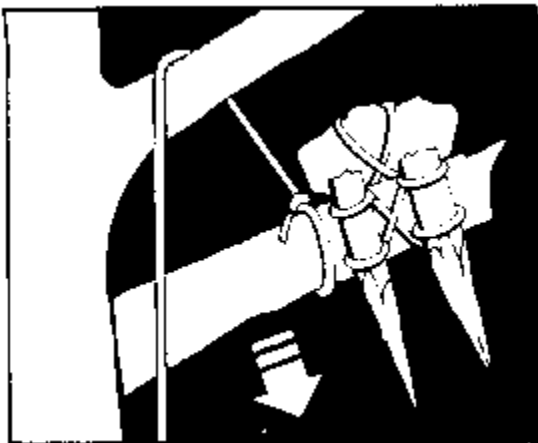

Same as tripwire deadfall but utilizing rocks to add weight and sharpened sticks to add trauma to the crushing blow.

Sprung Spear

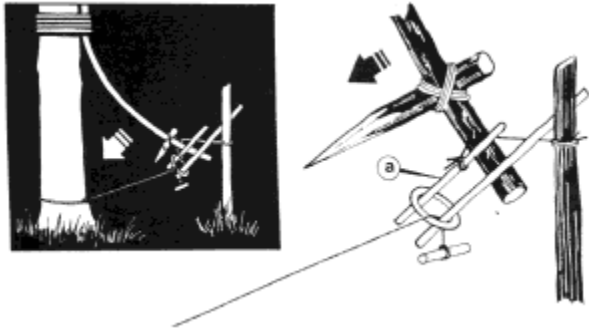

This is a VERY dangerous trap, it should always be constructed and approached from behind the spring of the trap, only attempt if you are confident that your cordage and other materials are strong enough. A springy shaft with spear attached is suspended over a trail. A slip ring made of SMOOTH material is attached to a trip wire and acts as a release mechanism. A toggle (a) and short line to a fixed upright hold the sprung shaft in tension. A further rod through the ring is tensed between the nearside of the sprung shaft and the far face of the upright, securing until tripped.

Baited Hole Noose



This trap is very useful for scavengers, drive 4 sharpened sticks into the pit, through the edges. Lay a noose across them attached to a peg outside the pit.

Drag Noose

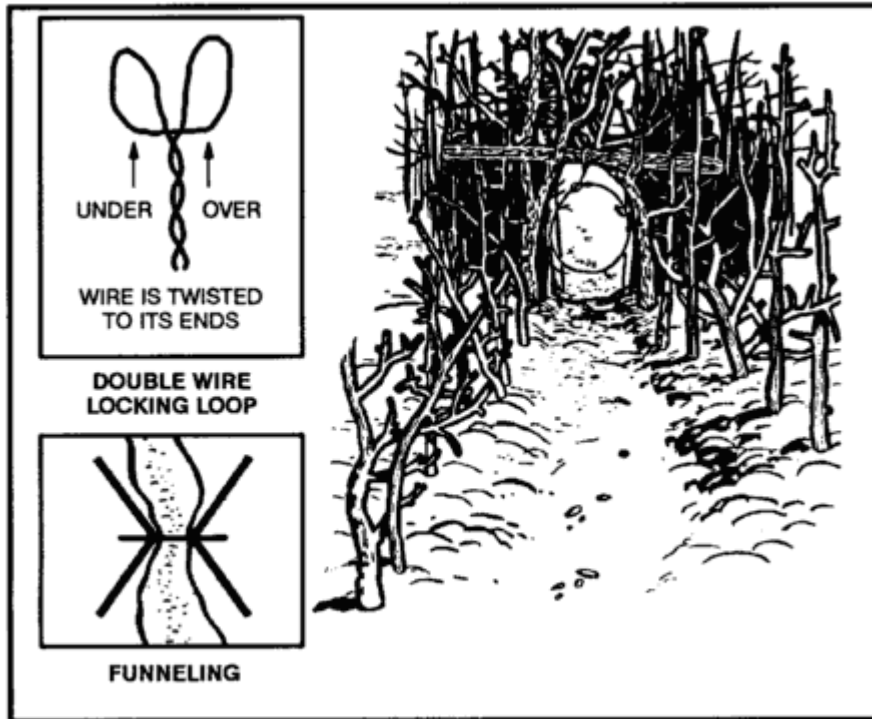

Figure 8-6. Drag noose.

Use a drag noose on an animal run. Place forked sticks on either side of the run and lay a sturdy cross member across them. Tie the noose to the cross member and hang it at a height above the animal's head. (Nooses designed to catch by the head should never be low enough for the prey to step into with a foot.) As the noose tightens around the animal's neck, the animal pulls the cross member from the forked sticks and drags it along. The surrounding vegetation quickly catches the cross member and the animal becomes entangled.

Squirrel Pole

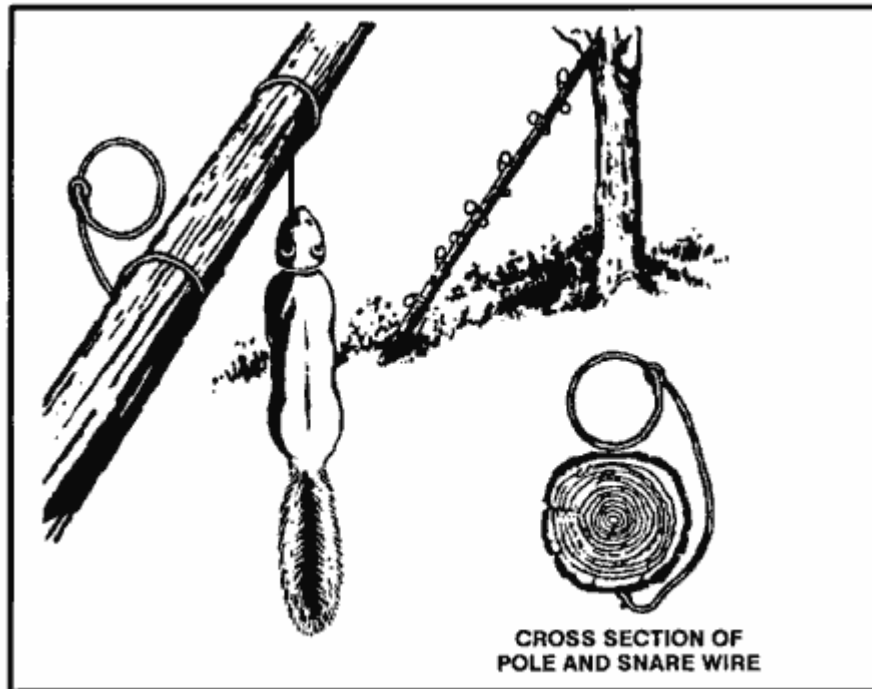

Figure 8-8. Squirrel pole.

A squirrel pole is a long pole placed against a tree in an area showing a lot of squirrel activity. Place several wire nooses along the top and sides of the pole so that a squirrel trying to go up or down the pole will have to pass through one or more of them. Position the nooses (5 to 6 centimeters in diameter) about 2.5 centimeters off the pole. Place the top and bottom wire nooses 45 centimeters from the top and bottom of the pole to prevent the squirrel from getting its feet on a solid surface. If this happens, the squirrel will chew through the wire. Squirrels are naturally curious. After an initial period of caution, they will try to go up or down the pole and will get caught in a noose. The struggling animal will soon fall from the pole and strangle. Other squirrels will soon follow and, in this way, you can catch several squirrels. You can emplace multiple poles to increase the catch.

Ojibwa Bird Pole

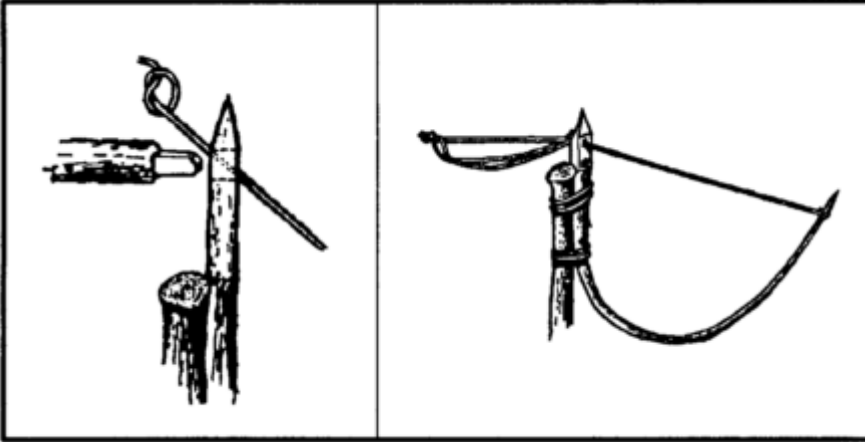

Figure 8-9. Ojibwa bird pole.

An Ojibwa bird pole is a snare used by native Americans for centuries. To be effective, place it in a relatively open area away from tall trees. For best results, pick a spot near feeding areas, dusting areas, or watering holes. Cut a pole 1.8 to 2.1 meters long and trim away all limbs and foliage. Do not use resinous wood such as pine. Sharpen the upper end to a point, then drill a small diameter hole 5 to 7.5 centimeters down from the top. Cut a small stick 10 to 15 centimeters long and shape one end so that it will almost fit into the hole. This is the perch. Plant the long pole in the ground with the pointed end up. Tie a small weight, about equal to the weight of the targeted species, to a length of cordage. Pass the free end of the cordage through the hole, and tie a slip noose that covers the perch. Tie a single overhand knot in the cordage and place the perch against the hole. Allow the cordage to slip through the hole until the overhand knot rests against the pole and the top of the perch. The tension of the overhand knot against the pole and perch will hold the perch in position. Spread the noose over the perch, ensuring it covers the perch and drapes over on both sides. Most birds prefer to rest on something above ground and will land on the perch. As soon as the bird lands, the perch will fall, releasing the over-hand knot and allowing the weight to drop. The noose will tighten around the bird's feet, capturing it. If the weight is too heavy, it will cut the bird's feet off, allowing it to escape.

Bottle Trap

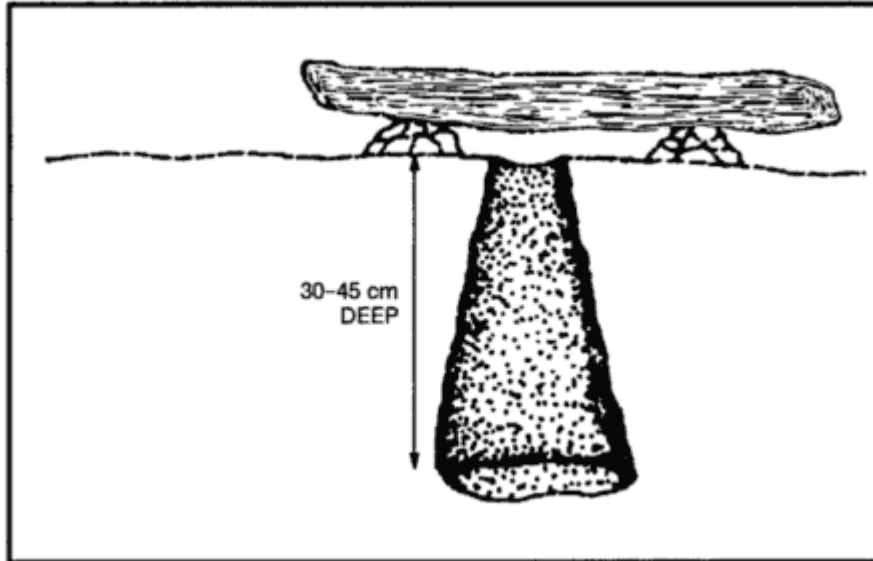

Figure 8-16. Bottle trap.

A bottle trap is a simple trap for mice and voles. Dig a hole 30 to 45 centimeters deep that is wider at the bottom than at the top. Make the top of the hole as small as possible. Place a piece of bark or wood over the hole with small stones under it to hold it up 2.5 to 5 centimeters off the ground. Mice or voles will hide under the cover to escape danger and fall into the hole. They cannot climb out because of the wall's backward slope. Use caution when checking this trap; it is an excellent hiding place for snakes.

Noosing Wand

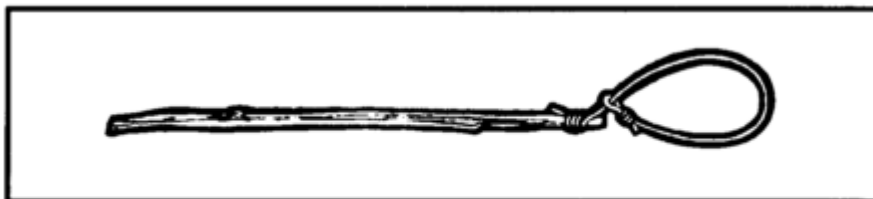

Figure 8-10. Noosing wand.

A noose stick or "noosing wand" is useful for capturing roosting birds or small mammals. It requires a patient operator. This wand is more a weapon than a trap. It consists of a pole (as long as you can effectively handle) with a slip noose of wire or stiff cordage at the small end. To catch an animal, you slip the noose over the neck of a roosting bird and pull it tight. You can also place it over a den hole and hide in a nearby blind. When the animal emerges from the den, you jerk the pole to tighten the noose and thus capture the animal. Carry a stout club to kill the prey.

Just a Reminder

These traps can kill, and yes, some can kill a HUMAN so, if you must practice:

Don't take children.
Don't practise in the cold or bad weather.
Don't practice under the influence of drugs or alcohol.
BE VERY CAREFUL ! Especially with the Sprung Spear.

Snakes

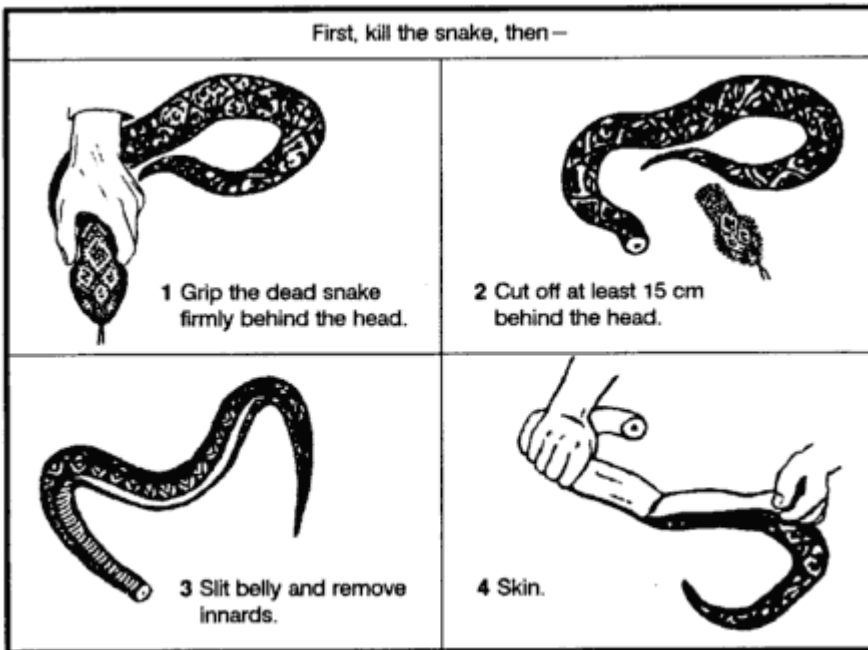

Figure 8-24. Cleaning a snake.

To skin a snake, first cut off its head and bury it. Then cut the skin down the body 15 to 20 centimeters. Peel the skin back, then grasp the skin in one hand and the body in the other and pull apart. On large, bulky snakes it may be necessary to slit the belly skin. Cook snakes in the same manner as small game. Remove the entrails and discard. Cut the snake into small sections and boil or roast it.

Birds

After killing the bird, remove its feathers by either plucking or skinning. Remember, skinning removes some of the food value. Open up the body cavity and remove its entrails, saving the craw (in seed-eating birds), heart, and liver. Cut off the feet. Cook by boiling or roasting over a spit. Before cooking scavenger birds, boil them at least 20 minutes to kill parasites.

Skinning and Butchering Game

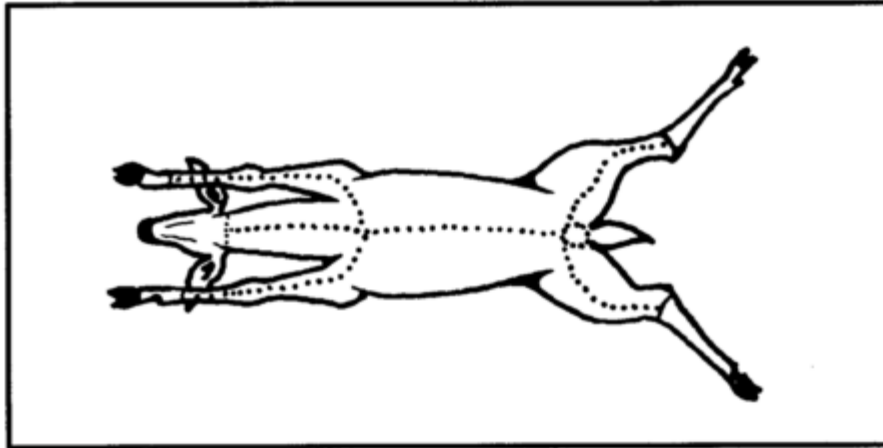

Figure 8-25. Skinning and butchering large game.

Bleed the animal by cutting its throat. If possible, clean the carcass near a stream. Place the carcass belly up and split the hide from throat to tail, cutting around all sexual organs. Remove the musk glands at points A and B to avoid tainting the meat. For smaller mammals, cut the hide around the body and insert two fingers under the hide on both sides of the cut and pull both pieces off. Note: When cutting the hide, insert the knife blade under the skin and turn the blade up so that only the hide gets cut. This will also prevent cutting hair and getting it on the meat.

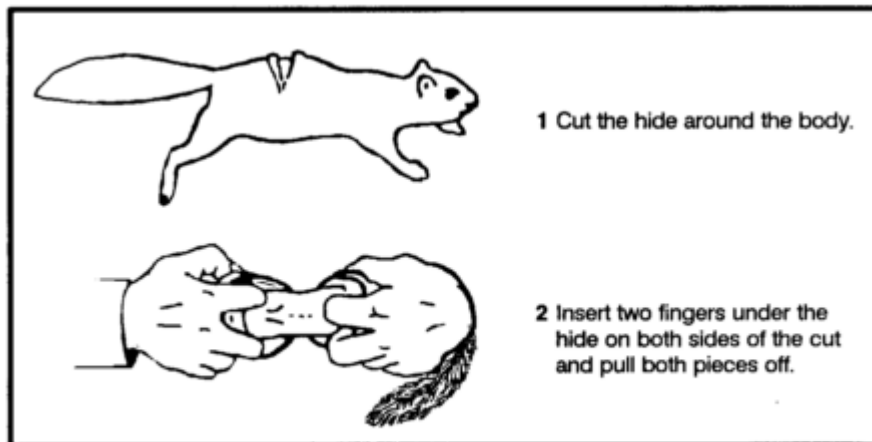

Figure 8-26. Skinning small game.

Remove the entrails from smaller game by splitting the body open and pulling them out with the fingers. Do not forget the chest cavity. For larger game, cut the gullet away from the diaphragm. Roll the entrails out of the body. Cut around the anus, then reach into the lower abdominal cavity, grasp the lower intestine, and pull to remove. Remove the urine bladder by pinching it off and cutting it below the fingers. If you spill urine on the meat, wash it to avoid tainting the meat. Save the heart and liver. Cut these open and inspect for signs of worms or other parasites. Also inspect the liver's color; it could indicate a diseased animal. The liver's surface should be smooth and wet and its color deep red or purple. If the liver appears diseased, discard it. However, a diseased liver does not indicate you cannot eat the muscle tissue. Cut along each leg from above the foot to the previously made body cut. Remove the hide by pulling it away from the carcass, cutting the connective tissue where necessary. Cut off the head and feet.

Cut larger game into manageable pieces. First, slice the muscle tissue connecting the front legs to the body. There are no bones or joints connecting the front legs to the body on four-legged animals. Cut the hindquarters off where they join the body. You must cut around a large bone at the top of the leg and cut

to the ball and socket hip joint. Cut the ligaments around the joint and bend it back to separate it. Remove the large muscles (the tenderloin) that lie on either side of the spine. Separate the ribs from the backbone. There is less work and less wear on your knife if you break the ribs first, then cut through the breaks.

Cook large meat pieces over a spit or boil them. You can stew or boil smaller pieces, particularly those that remain attached to bone after the initial butchering, as soup or broth. You can cook body organs such as the heart, liver, pancreas, spleen, and kidneys using the same methods as for muscle meat. You can also cook and eat the brain. Cut the tongue out, skin it, boil it until tender, and eat it.

Smoking Meat

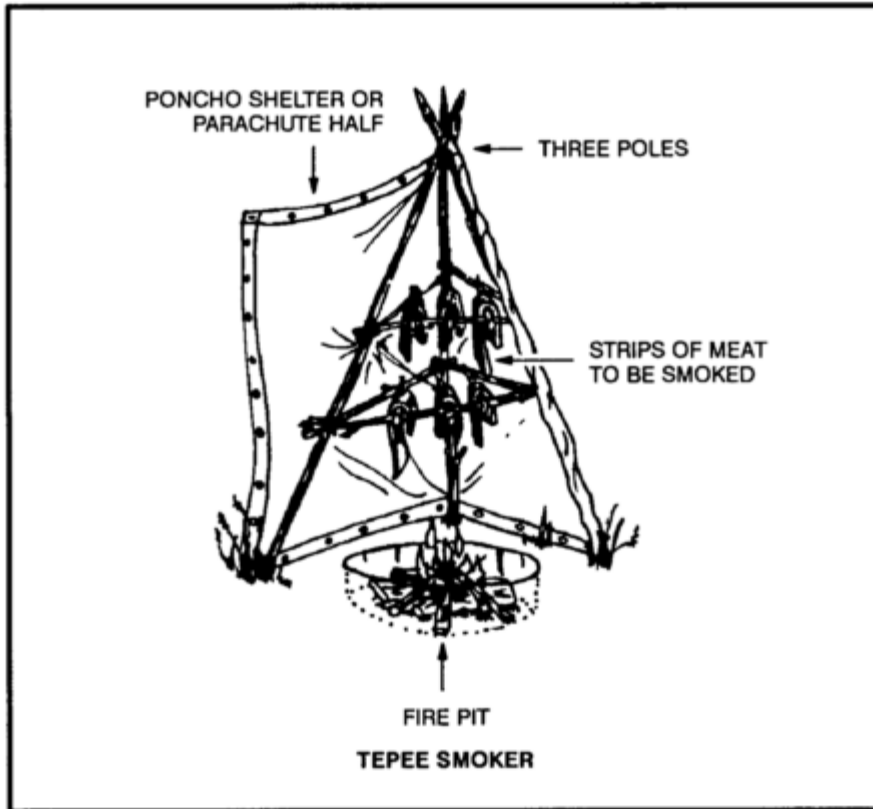

Figure 8-27. Smoking meat.

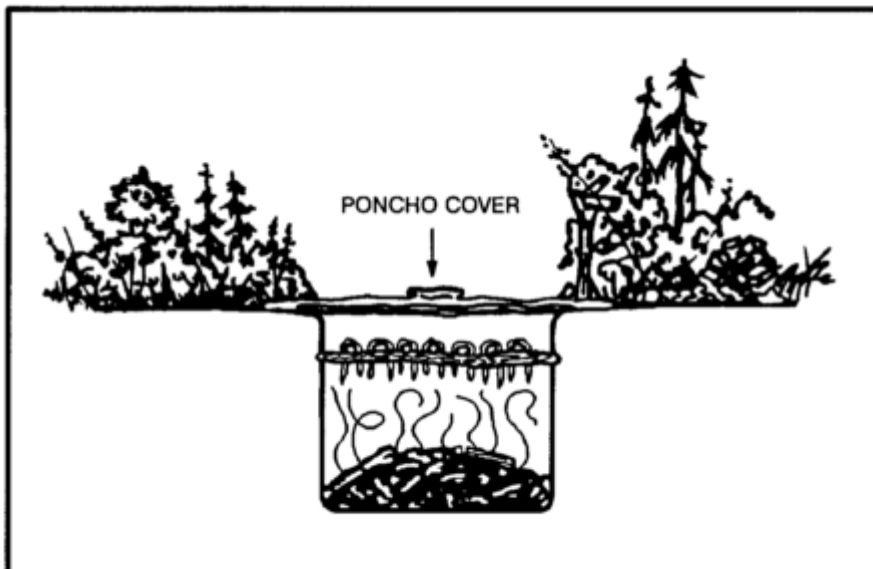

Figure 8-28. Smoking meat over a pit.

To smoke meat, prepare an enclosure around a fire. Two ponchos snapped together will work. The fire does not need to be big or hot. The intent is to produce smoke, not heat. Do not use resinous wood in the fire because its smoke will ruin the meat. Use hardwoods to produce good smoke. The wood should be somewhat green. If it is too dry, soak it. Cut the meat into thin slices, no more than 6 centimeters thick, and drape them over a framework. Make sure none of the meat touches another piece. Keep the poncho enclosure around the meat to hold the smoke and keep a close watch on the fire. Do not let the fire get too

hot. Meat smoked overnight in this manner will last about 1 week. Two days of continuous smoking will preserve the meat for 2 to 4 weeks. Properly smoked meat will look like a dark, curled, brittle stick and you can eat it without further cooking. You can also use a pit to smoke meat.

Drying Meat

To preserve meat by drying, cut it into 6-millimeter strips with the grain. Hang the meat strips on a rack in a sunny location with good air flow. Keep the strips out of the reach of animals and cover them to keep blowflies off. Allow the meat to dry thoroughly before eating. Properly dried meat will have a dry, crisp texture and will not feel cool to the touch.

Other Preservation Methods

You can also preserve meats using the freezing or brine and salt methods.

Freezing

In cold climates, you can freeze and keep meat indefinitely. Freezing is not a means of preparing meat. You must still cook it before eating.

Brine and Salt

You can preserve meat by soaking it thoroughly in a saltwater solution. The solution must cover the meat. You can also use salt by itself. Wash off the salt before cooking.

Fox Trap - The Buntine

Australian designed, Australian made, multi-purpose for foxes, feral cats and wild dogs

- Premium quality design and build, heavy duty metal mesh, built to last
- Big enough to be serious about fox and dog trapping, gets the body and tail in before the trap door drops
- 10 kg of hot-dipped galvanzied Australian One Steel
- Simple and smooth to operate
- Lockable side access door for easy access to bait cradle at the far end of the trap
- Big enough and sturdy enough to withstand foxes bashing the trap to find a weak spot to escape
- Will also trap the other feral meat eaters - wild dogs and feral cats
- Live capture - if your own dog is trapped, simply let it out, no harm done
- Poison-free trapping
- Quality spot welding, attention to detail
- Solid sheet metal back wall to deter animals from trying to access bait at the far end of the trap
- Check traps daily to remove them from exposure

The fox is an introduced feral animal and is not native to Australia. It is a very efficient hunter and killer of native Australian wildlife and livestock. A real fox trap needs to be long enough and large enough to get the fast moving fox body and tail inside the trap before the trap door drops behind it.

Suggestions for trapping foxes

Keep your scent off the trap as much as possible. Smoke the trap if needed, see below.

Build the fox trap into the wall of the chook yard or pen. The fox thinks it has found the easy way in to get a chook or twenty and heads in to the trap opening. Still use meat in the trap to trigger the dropping of the door behind the animal. The external locking bar drops and the fox cannot get out.

Have the open end of the trap in line with the wall of the pen with the body of the trap inside the chook pen.

Cover the floor of the trap with sand, not soil, (soil rusts it eventually) and throw in a few nearby leaves or small twigs on top of the sand to make it look more like normal ground. The sand prevents the fox from feeling the metal mesh under its feet which is unnatural for it.

Anchor the trap firmly to level ground with a tent peg in each corner to prevent the trap from moving in the wind - movement will make a suspicious fox unlikely to ever go in. Four tent pegs to anchor it also prevent the fox from rolling the trap and escaping. When the trap is upside down, the locking bar can drop the other way, the door is opened and the fox walks out, never to return for seconds.

Lure a fox/dog/cat to the trap by dragging something rotten (sheeps head or other smelly meat) on a rope in a large circle around the trap and lead the scent trail into the entrance of the trap.

Bait inside the trap with fresh raw meat, liver or chicken necks in the bait basket. When the fox has a go at this bait, it triggers the trap door behind and CLANG, you have this fox.

Once a fox finds live poultry, it will keep coming back until the last of the poultry is killed or taken, unless you trap or kill it. The sooner the better for the poultry, lambs and native wildlife, especially birds.

To outsmart a cunning fox in an open area of a yard or paddock, place the trap where you think the foxes are. Anchor the trap to the ground with four tent pegs, lay sand on the floor, set the trap door up but tie it up so that the trap door will not drop. Walk away for a few days, even up to a week. Let the suspicious fox get used to seeing the same object in the same place to increase its familiarity and reduce its natural suspicion. Then educate the fox.

Still keeping the trap door wired up so it will not drop, place a piece of raw meat just inside the entrance on the floor. Come back next day. If the bait is gone, good. Place another piece of meat a quarter of the way inside the trap. Repeat this for a second day, placing the bait half way inside the trap. Then again for the third day, placing the bait three quarters of the way inside the trap. Without changing the type of bait, unwire the trap mechanism so the door will drop and place the bait in the bait basket on the fourth day. The fox comes back inside the trap for its usual easy feed and CLANG, you trapped it. Older foxes are smarter and more experienced than younger foxes and can be harder to trap so it is worth the effort.

Know the nature of the fox

Male foxes can take one chook at a time for a meal. Vixens with young take many at a time. Mother fox can demonstrate how to kill chooks and then the young practice killing on what is left. Mostly they are nocturnal but are brazen enough to take poultry literally from under your nose in broad daylight. They can all keep taking chooks in the one raid and burying the carcasses in a stash somewhere else for a feed later on. Same applies for a paddock of newborn lambs, especially with the first born of twin lambs. While the ewe is giving birth to the second twin, the first born is defenceless and easy prey for a waiting fox.

Never under-estimate the cunningness and intelligence of a fox, just understand their nature and then outsmart them.

Give it three or four weeks (depending on rain) after trapping a fox, another fox is likely to move in and take over the same territory. There is no shortage of foxes (or feral cats) out there. Research from a Melbourne Age article said there were 10 foxes per square kilometer in Melbourne and four foxes per

square kilometer in country Victoria. Foxes know where to get a feed and where to hide in plain sight. Along rivers in cities is one favourite fox habitat.

Foxes mark their territory by urinating and prominently-placed easily-recognizable pointy-ended droppings on top of objects like rocks, other animals droppings, even the top of fence posts (picture that acrobatic feat), as a warning to others to stay out of its territory. This scent fades in time if not regularly freshened up by the fox, or until you trap it.

An old timer confided that in his day, they used to use human droppings at the base of every second fence post to mark off their territory. to keep the fox at bay. Same principle of demarkation that a fox understands.

What to do with a trapped fox

Be careful. Forget the cute photos and cartoon cliches. The trapped fox is a dangerous wild animal intent on savagely biting anything it can, especially you. If you have to move a live fox in the trap, wear solid protective gloves and use the two external handles. It will be heavy. Be prepared for serious aggression. This precaution applies equally for feral cats and wild dogs that you trap.

The best kill of a feral animal is a quick humane kill. Shooting while still trapped in the cage is the fastest. Watch out for ricochets. If you do not have a .22, ask a neighbour who does have one. Or contact your local council Ranger or the RSPCA for assistance and information, before you trap the animal.

Nothing eats a dead fox. Compost is a solution as long as it has not been poisoned. Recycle it by turning it into nitrogen fertilizer for the garden. Bury it soon and deep to keep out the flies.

Figure-4 Deadfall

A Figure-4 Deadfall trap relies on a trigger that is roughly in the shape of the number "4", hence the name.

The mechanism of this trap is explained in detail at the bottom of this page.

But first, some overview photos of this trap...



Here is a nice overview photo of the Figure-4 Deadfall trap mechanism.

Trap constructed by Julia Kristof



A figure-4 deadfall trap set, using a pine board to simulate a deadfall, with a rock on top for weight.

Trap constructed by Alex Harwood

Another figure-4 deadfall, again using a pine board to simulate the deadfall part.

Click on the small photo to see a movie of this trap being triggered



Windows Media format (WMV)
320x240, 319 KB



Trap constructed by Julie Liptak



Trap and photo by Allan "Bow" Beauchamp

Here is a small figure-4 deadfall in a bush situation.

Detailed photos of the parts of the Figure-4 trigger:

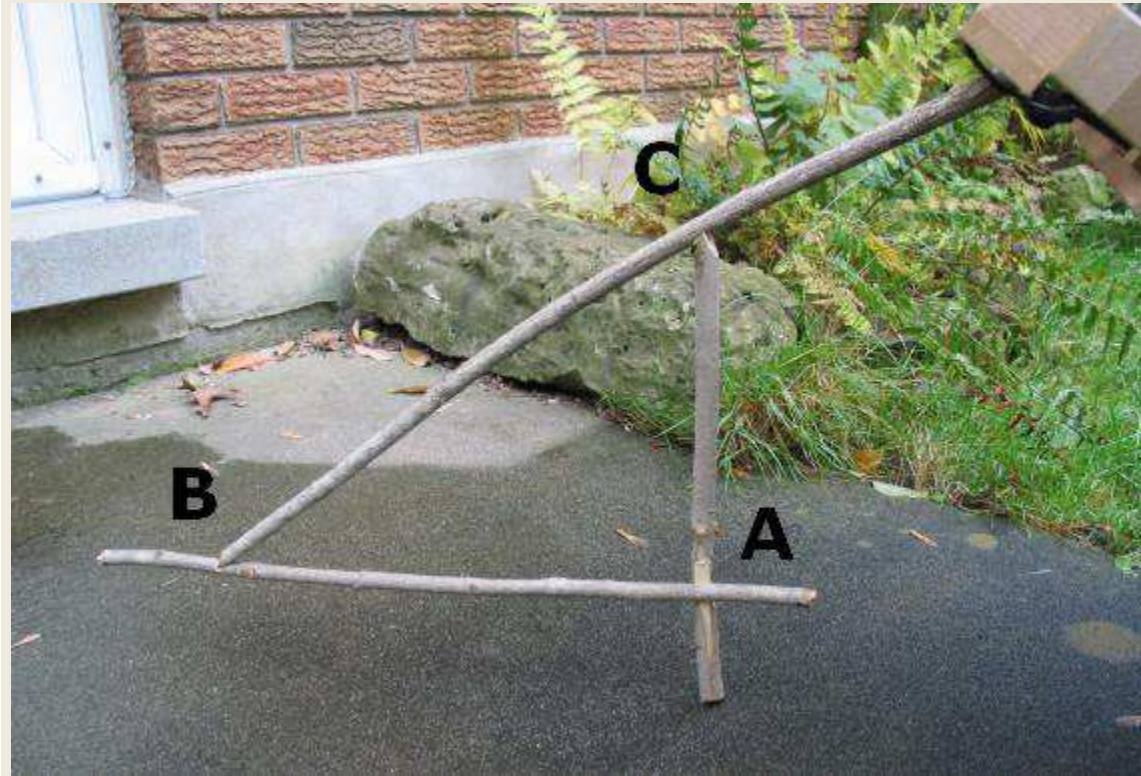

Trap constructed by Walter Muma

The basic principle of the Figure-4 trigger, and how it works:

- A rock or other weight rests on the end of the diagonal stick. This supplies downward pressure to the end of that stick.
- The diagonal stick rests on and pivots on the vertical stick at "C". This keeps the diagonal stick from slipping away to the left.
- The diagonal stick is also held in place by having the end rest in a notch at "B".
- The pressure of the diagonal stick is pulling the horizontal stick towards the left.
- The horizontal stick is held in place by the notches at "A".
- "A" is where the actual trigger mechanism is located.
- The bait is placed at the end of the horizontal stick to the right of "A" (this stick can be made longer as necessary), so that it is located directly under the weight.
- When the animal takes the bait at the end of the horizontal stick, the trigger at "A" is released. The horizontal stick falls to the ground, and the diagonal stick flips up and out in a counter-clockwise arc. This allows the weight to come crashing down on the animal, killing it instantly.
- Note that the vertical stick should be resting on a hard surface, such as a flat stone. Otherwise it may dig into the ground and cannot fall out of the way when the trap is triggered - the deadfall weight will come to rest on the vertical stick and won't fall to the ground.
- Note also that it is usually good practice to put something hard on the ground under the whole trap, or place the trap on rock. Otherwise, the deadfall, when it falls, may not kill the animal, only injure it, since the animal may be pressed into the soft ground.

Trap constructed by Walter Muma



A

Looking down along the vertical stick.

Note that the vertical stick has been squared off.

The horizontal stick has a square-ended notch cut into it.

The pressure of the diagonal stick is pulling the horizontal stick to the left.



B

Here the diagonal stick is pushing the horizontal stick out towards the left.

Side view.



C

The pivot point at the top of the vertical stick.

This holds the diagonal stick in place, preventing it from slipping away to the left.

Side view.

Trap Baiting

by Tom Brown Jr.

Trap baiting is a science in itself. In order to know where to place a trap and what bait to use in a survival situation, a person must be a good tracker.

First of all, he must find himself a location that is heavy with animals. A location in a transition area, where forest meets field or field meets stream is always the most ideal location. Transition areas are where most herbivore animals live -- where there are herbivores, there are always the carnivores. Once we find a transition area, we must read the general sign of the landscape to figure out the ebb and flow of life, which trails and runs are heavily used, and put into our mind where we will set our snares and deadfalls. We must look around the area very carefully, taking note of what the animals have been eating. Winter time is one of the best and easiest times to bait animals because animals such as rabbits and deer are going to be hitting the higher buds -- the buds of bushes and trees. Eventually they are going to eat up to what we call a browse line, which is as high as they can reach.

To bait a trap, find the plant that is most heavily browsed upon, collect the upper buds and bait your traps with that. The same principle holds true when baiting traps at any other time of year. Simply find out which plant or plants in the area have been totally eaten, and find out which plants have not. Their favorite plants will always have been eaten first. For instance, if you find that a groundhog has eaten all the alfalfa in an area and is now starting on the clover, you would not attempt to bait your trap with clover because there is too much of it. Instead, bait the trap with alfalfa.

Baiting is a science, a combination of tracking, nature observation, knowing the ebb and flow of life of each of the animals, and knowing what foods they eat. Before trapping, you should take careful note of what has and has not been eaten and to what degree this food reserve has been eaten. The one that is always eaten first seems to be the best bait material.

One of the baits that seem to attract most herbivores is cooked grain that has been crushed and pounded into a semi-doughy-like mass. This breadstuff, or primitive bread, makes excellent bait for most herbivores.

The Lost Traps

Taught by Grandfather to Tom Brown
by Dan Stanchfield

The lost traps are three variations on the paiute trap that you learned in the standard class. Why would you need to use them? Well, each one is increasingly harder to set, which means that each one is increasingly more sensitive, which means that each one is faster. This logic comes from a quote from Tom Brown, "The harder to set a trap is, the more sensitive it is."

So why is faster more preferred? It's not, if you want to miss the animal or just catch it by the leg and let it suffer. If you need food and you are dealing with fast and tricky animals then you have to use faster traps.

I eat very little because my ancestors were supposedly agrarian based, and since animals store more of the toxins from the ever increasing pollution than plants. But if I did have a need for meat, I'd want to be able to provide for myself, family, and friends. Also, I am fascinated by traps or any primitive skill that may soon become "lost."

I learned these all from Tom Brown, Jr. in January of 1998. I am writing this article for two reasons. One is to give credit and appreciation to Tom for passing on this knowledge to me and thus, me to you.

The second reason is so you can all have fun experiencing the frustration of setting these meat traps. Please work with these traps instead of just talking about them. I do enough talking for all of us. Knowing and doing are two different things. Trap mice or use boxes instead of deadfalls on your pets; just do it one way or another. And have fun.

The next article will include a stringless paiute trap that Grandfather invented and some tips on why you want your diagonal at 45 degrees.

Keep Tracking, Daniel S.

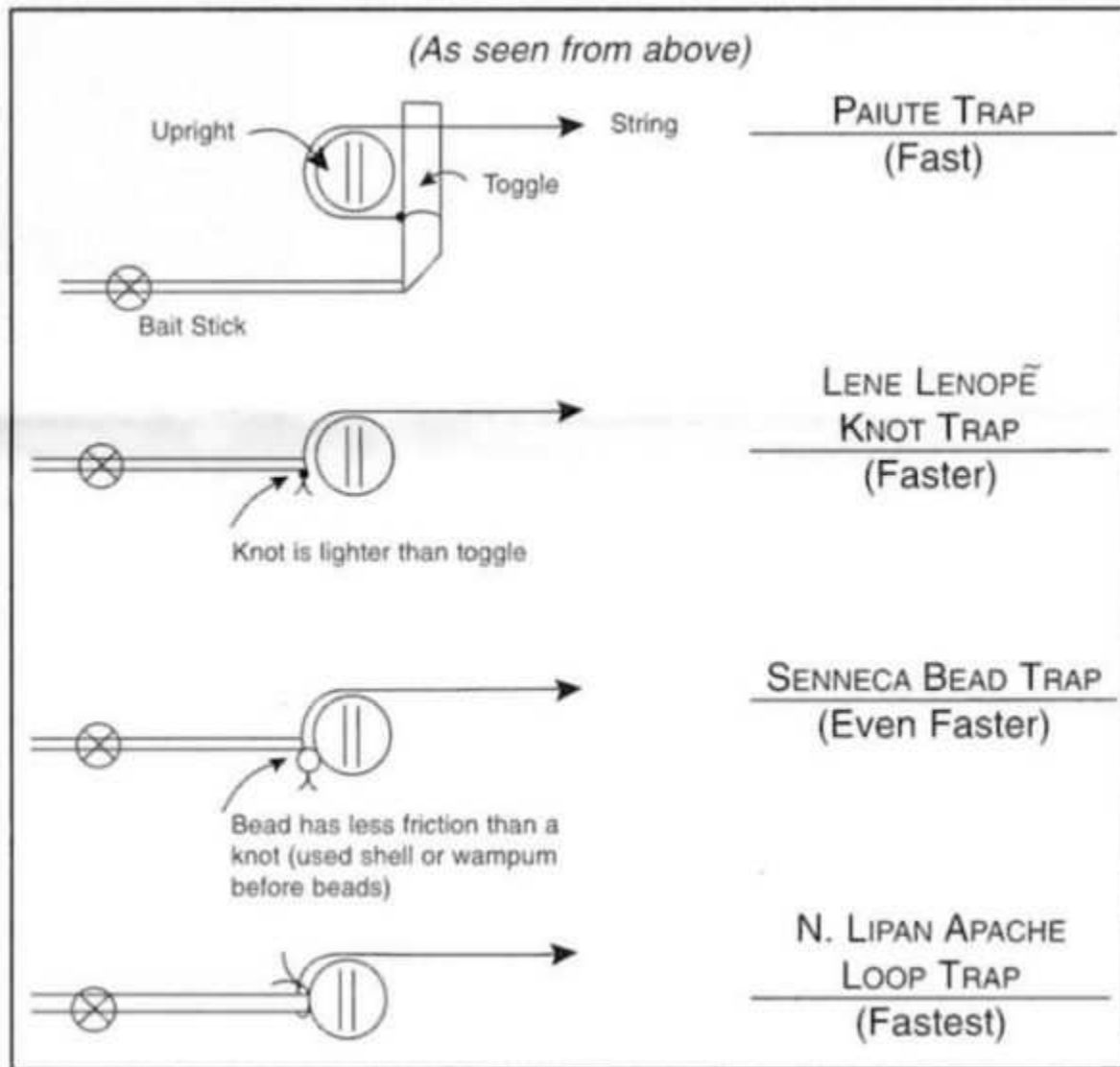

From *True Tracks*, Fall 1998, published by the Tracker School.

At Home In The Wilderness Part IV: Hunting and Traps

by Tom Brown Jr.

from Mother Earth News, Issue #74

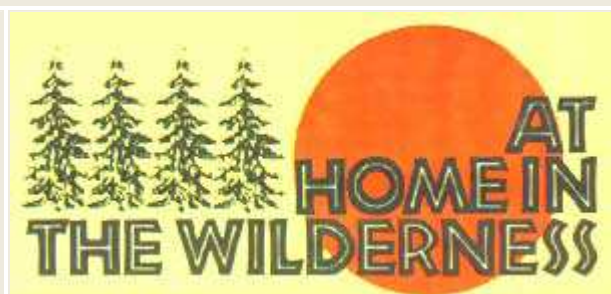

Most people, when trying to imagine how they might react if faced with a survival situation, immediately focus their attention on the problem of obtaining food. However (as those of you who've read the earlier installments in this series of articles already know), filling one's belly rates pretty low in the list of

wilderness survival priorities . . . following shelter, water, and—especially in cold climates—fire.

The fact is that almost any reasonably healthy human being can get along for quite a few days with no food at all . . . and would suffer only hunger, and perhaps attendant stomach cramps, as a result of doing so. Therefore, the time for the survivalist to begin foraging for edibles is only after his or 'her more urgent needs have been taken care of.

CLOCKWISE FROM LEFT: The "business end" of the very effective rolling snare . . . and the trigger mechanism The figure 4 deadfall . . . its upper notch . . . and the lower joint. Note that the components just barely mesh. This kind of assembly makes for a sensitive trigger . . . Detail of the Paiute deadfall's trigger . . . and the complete, ready-to-drop trap . . . It's best to be cautious when setting the rolling snare.

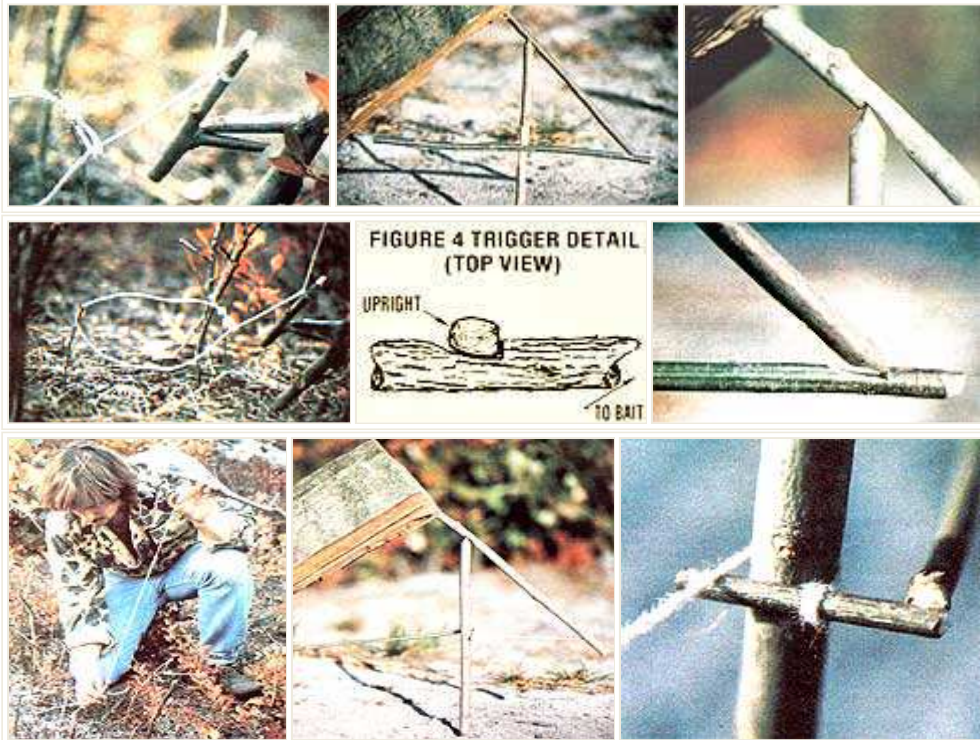

Now in most parts of North America, the most easily collected survival foods are wild plants. However, since many native vegetables aren't available in the winter months (and because most regular MOTHER-readers already have a pretty fair grounding in edible plant identification), I've decided to discuss methods of gathering animal foods here. And the techniques that I'll focus on are hunting (with a simple throwing stick) and trapping.

HUNGER IS THE BEST APPETIZER

Naturally, when eating is a matter of life or death (as it could be if you were stranded for an extended period of time), an individual can't allow his or her dietary preferences to get in the way. You should know, then, that virtually all mammals are edible (in fact, when skinned and cleaned, very few animals can't be safely used as food). It's important, however, to avoid eating any creatures that show signs of sickness . . . and, if possible, to cook all meat (usually either on a spit or in a crude stew) until it's well done. Remember, too, that such protein sources as grubs, grasshoppers, cicadas, katydids, and crickets

shouldn't be passed up!

THE MOST PRIMITIVE WEAPON

A basic throwing stick is, quite simply, a sturdy hunk of branch. The optimum size and shape will vary somewhat, depending upon personal preference, but I like a stick about 2-1/2 feet long and approximately half as thick as my wrist. Of course, some primitive peoples have turned the making of throwing sticks into an art form (consider the Australian kylie, or hunting boomerang, which is carved to an aerodynamic profile that actually allows it to fly farther than an unshaped stick of similar size and weight could be thrown). But for our purposes, we'll be discussing the handling of a weapon that requires nothing more, perhaps, than being broken to a comfortable length before it's put to use.

Such a basic club can be thrown either overhand (when, for instance, you're trying to knock a squirrel from the side of a tree) or sidearm (when you're in an open area, where brush won't interfere with the stick's flight). In using the first method, point your left foot at the target (if you're a right-hander southpaws can simply reverse these directions). Then, holding the smaller end of the stick loosely in your right hand, bring the weapon back over your shoulder and hurl it, with good end-over-end spin, straight at the mark. At the moment of release, your shoulders should face the game squarely.

The sidearm throw is similar to the motion used in stroking a tennis ball with the racket. Point the left toe at the animal, bring the stick to a cocked position at your side, and throw it . . . squaring your shoulders and snapping the club—as if you were cracking a whip—to give it spin.

Always be sure to carry your throwing stick when away from camp for any reason. Not only is there a chance that a small bird or animal will suddenly appear within range, but there's also the possibility that you'll encounter other food sources (say, nuts or fruit) that can be knocked down with the club.

I don't have the space to go into any detail about stalking techniques here. In general, you should avoid any abrupt movements . . . walk slowly, feeling the ground (or, perhaps, a brittle twig?) beneath each foot before putting your weight upon it . . . and try to time your movements to coincide with the feeding patterns you observe in your quarry (most animals will alternate regular periods of feeding with pauses to survey their surroundings for danger). Remember, though, that this is a very rudimentary outline, and that—as always—the time to practice this particular survival skill is before you need it.

THE THREE TOP TRAPS

There are probably well over 100 traps that can be fashioned—using primarily foraged materials—in a wilderness setting. But although any student of outdoor survival would be well advised to acquaint him- or herself with as many designs as possible, I consider the rolling snare, the figure 4 deadfall, and the Paiute deadfall to be the most easily made and versatile of the lot.

A snare, as you may know, is little more than a noose—fashioned from wire, string, sinew, or handwoven cordage—positioned in such a way that it can "lassoo" an animal. The rolling snare, in particular, is placed directly along a well-traveled animal run or trail. When the beast unknowingly puts its head through the loop, the trigger is released, and a sapling—to which the noose is tied—whips upright, often breaking the animal's neck and thus killing it instantly. You must, of course, be selective when choosing a site for your snare . . . if it's set on a trail that's used by animals larger than those you're after, they might blunder into, and destroy, the device.

The rolling snare is one of the easiest survival traps to set up. And, because the pressure points on the trigger mechanism (as illustrated in the accompanying photos) are rounded rather than squared, it's not

likely to freeze up during cold weather. Be careful, though, when setting this or any snare that depends upon a bent tree for its power, as the sapling could unexpectedly spring up and catch you in the face.

THE FIGURE 4 DEADFALL

A deadfall is a baited trap which, when triggered, allows a weight to drop on the animal, often—as the term implies—killing it outright.

The figure 4 takes its name from the shape of its trigger assembly and is about as simple to construct as any trap I know of. The trigger is composed of three sticks, two of which—when used for rabbit-sized animals—will each be about six inches long, and the third eight inches (the sizes will vary some with the type of animal to be trapped). The weight is usually a large, flattish rock or a log.

The figure 4 trap should be set near trails or established feeding areas, but—since it depends upon bait rather than upon a beast's unwittingly stumbling into it—never directly in a run or line of travel. Remember when assembling it that the vertical stake should not be positioned beneath the rock or log, that the bait should be attached to the crosspiece and as far under the weight as is practical, and that a small fence of twigs around the "outer" portion of the upright can prevent an animal from inadvertently setting off the device by striking the trigger while not under the log or rock.

THE PAIUTE DEADFALL

This trap is similar to the figure 4, but has the advantage of a more sensitive, "faster" trigger. Again, the upright should be positioned well out from under the lip of the weight and the bait—on the crossbar—well beneath it . . . and the trap itself will be most effective if located near an area of game activity but not actually in a well-traveled run.

As you can see in the accompanying photos, a piece of string, sinew, or woven cordage will be needed to construct this trap (some threads unraveled from clothing and twisted together will usually work quite well). The Paiute is more difficult to set up than are the other two traps described here, but it's also the most effective of the bunch.

TRAPPING TIPS

You've probably already gathered that there's a good bit more to survival trapping than simply constructing your deadfall or snare in the middle of a convenient field. In order to obtain the best results with these do-it-yourself game getters, you'll have to understand a little about animal movement patterns . . . the dietary likes and dislikes of the beasts you're after . . . and the different methods of making your structures appear "natural" so the animals' suspicions won't be aroused.

Your most important task will be to locate areas of high game activity, generally by "reading" the landscape. Usually (the wilderness always produces exceptions to human rules) the most productive areas to scout will be those around sources of water . . . and those in edge environments, where forest meets field, field meets meadow, and so forth.

In such a location, you may well be able to spot specific trails, runs, day beds, lays, and feeding areas. By doing so, you can place your trap in such a way that it'll have the best possible chance of being encountered by the animal you're after.

Trails are heavily used tunnels or paths. When following such a wildlife "freeway", you should be able to note animal scat, hair, and such that will indicate the type of creature most often using the path.

Remember, though, that even if deer tracks-for instance-have all but eliminated any other signs from a trail, odds are that a number of smaller animals are using it, too. Wild creatures will follow the easiest route available unless they're either pursuing or being pursued.

Runs are the smaller arteries that connect established trails to feeding, bedding, and watering sites . . . and are subject to change as food and water supplies come and go. Since each run's use is typically limited to one species, its size will often provide some clue to the type of animal using it. (Traces of scat and fur, again, will help you make a positive identification.) By following runs-carefully, causing as little disturbance as possible to these potential trap locations-you may be able to find the areas of animal concentration to which they'll usually lead.

Day beds and lays are spots in which beasts seek cover and/or sleep. Beds are generally used quite frequently (though one animal might well have several of them), and usually appear as well-worn depressions in the grass or ground. Lays, on the other hand, are less obvious-often showing up as areas of partially crushed weeds or brush-and are typically found near feeding sites. The pattern of beds and lays surrounding a known food source can help you predict routes of animal travel, and thus choose good locations for your traps (this is especially true when setting snares, as your quarry will actually have to run into such a trap to be caught).

Feeding areas-which can be located by careful observance of the signs described already-will, for herbivorous animals, likely be locations rich in grasses, clover, and tender new growth . . . or, especially in winter months, young trees and brush with edible bark, twigs, and buds.

By examining the food plants in such an area, it's often possible to determine what sort of animals are feeding there. A diagonal bite that cuts off a plant stalk at about a 45° angle is typical of such rodents as rabbits and woodchucks. Straight, finely serrated bites will often indicate that members of the deer family have been dining . . . while obviously chewed-upon greenery is usually a sign that predators have been rounding out their diets-with a little plant foraging.

You will, of course, want to take special note of exactly what food seems to be preferred by the species you hope to catch. Furthermore, it's best to try to locate a favorite snack that, because it has been pretty much finished off, has been temporarily abandoned for a second-choice edible. If, for instance, you note that all of the red clover around a group of woodchuck dens has been eaten, and that the animals are now resorting to a diet of grasses, it may be worth your while to scout beyond the 'chucks' range and-if you can-bring back a batch of that rare clover to use as bait.

"Naturalizing" your traps, in order to lessen the chance that animals will steer clear of them, will improve your chances of making a catch. Leave bark on the trigger assemblies, and rub dirt on any cut surfaces to prevent them from attracting unwanted attention. When working on a trap, be sure that your hands are well rubbed with mint, leek, or some aromatic weed to disguise the human scent. In the winter, it's sometimes possible to accomplish the same result by smoking a finished trigger assembly over a fire, and then handling it with gloves that have also been well scented with wood smoke. (Some trappers will smear their hands with scat, or with scent from the glands of an animal caught earlier. The notion may sound unpleasant to you now, but there's little room for niceties in a true survival situation!)

Once your traps are naturalized and set, be sure to check them at least once a day . . . to prevent your quarry from being stolen by a predator or (in hot weather) decomposing, and to minimize the suffering of any creature that might have been caught but not killed. Carry your throwing stick when visiting the traps. A hard blow to the back of the head will, for most of the small animals that you'll be likely to catch, result in a quick and relatively painless death.

LEARNING BY DOING

As mentioned above (and over and over in this series of articles), the time to fine-tune your survival skills is before you have to use them. Practice reading animal signs, locating feeding areas, and so on at every opportunity. Carry a throwing stick on your hikes and indulge in a little target practice . . . flinging it at stumps, clumps of grass, and the like.

You should certainly experiment with making survival traps, too . . . but don't leave them set in an attempt to catch animals when doing so isn't absolutely necessary. For one thing, you would likely cause needless suffering and death, and -for another-none of these traps is legal in any state . . . unless the trapper is truly in a life-threatening situation.

Finally, remember that this article is little more than an introduction to the subject of survival trapping. Take the time to visit your local bookstore or library for more sources of information, look into the possibility of attending one of the survival courses available, and make the building and refining of your store of outdoor skills a regular and pleasant part of your life . . . when you're hunting, fishing, camping, or simply taking a shortcut across a vacant lot to go to the store. Only after you develop confidence in your own abilities will you be truly able to feel at home in the wilderness.

Snapping Turtle Trap



A Snapping Turtle trap, made by "Doc".

The turtles enter at the right side, find their way into the central chamber, and can't get out.

The left end opens up for removal of the turtles.



The entry to the trap.



The other end, shown closed, where you would remove the turtles.



Opening

Friction Point Split Stick Trigger

The trap shown in these pictures is presumed to have been commonly used in the southwest. Many artifacts have been found. The most commonly trapped animal was assumed to be pack rats.

This type of split-stick trigger relies on the friction between the ends of the pieces of wood. This friction is due in part to the pressure of the upper piece of wood against the bottom piece. As well, the two ends must be a bit rough or there's no way that they would stay together.

This type of trigger could be extremely sensitive.

Bait is applied to the "pointy" area.



Trigger by [Rob Bicevskis](#)



Trigger by [Rob Bicevskis](#)



The key to this trap is to use an obsidian knife to cut the pieces.

If a normal knife is used, the "friction point" where the two sticks come together is too smooth and the trap cannot be set. (Using a small saw to cut the pieces also works!)

Photo and trigger by [Rob Bicevskis](#)



Photo and trigger by [Rob Bicevskis](#)

The second picture shows a more sensitive version of the trap.

In this variation

John McPherson Style Deadfall

John McPherson describes a trigger mechanism of his own invention in his books.

This trap relies on a spring stick placed on the ground that, when triggered, will pull the vertical stick holding up the deadfall out of the way, allowing the weight to fall.



Trap constructed by Julia Kristof.

An overview of the trap.

In this one, the spring is provided by placing the spring stick between two pegs stuck into the ground. The trigger is visible under the plank - in this case, it is rather deeply under the plank (which is the deadfall).

When the trigger is sprung, the spring stick is released, pulling the vertical stick out, allowing the deadfall to fall.



Trigger constructed by Walter Muma

Here is a photo of the trigger. The upper stick is being pulled towards the left by a string tied to the spring stick. It is being held back by a short string tied to a peg in the ground.

The two faces that meet are left rounded to enhance the sensitivity of the trigger.

The bait can be placed anywhere on the mechanism, since even the least little bit of movement will spring the trap.

So, for example, if the bait is placed along the horizontal string, when it is moved slightly, the upper peg will flip out away from the lower peg, releasing the spring stick.



Trigger constructed by Walter Muma

The sensitivity of the trigger can be adjusted by varying the height of the upper peg in relation to the top of the lower peg and the string holding it to the lower peg.

This photo shows a very sensitive trigger layout. The upper peg is barely being held in place by the lower peg. Only a tiny bit of the point of the upper peg is being held by the string to the lower peg.



Trap constructed by Walter Muma

In the trap shown here, the vertical stick holding up the deadfall is angled, making it much easier for the spring stick to pull it away.

Note that you must consider the effect of the peg sticking up out of the ground under the deadfall (you don't want it to prevent the deadfall from falling completely).



Trap constructed by Walter Muma

A variation of this trap.

Here, the spring stick is positioned so it will kick the vertical stick out of the way. This eliminates one piece of cordage.

Again, the vertical stick should be placed on a smooth stone so it will move readily when it needs to.

Some trigger variations...

In this trigger variation, no cordage is needed at all (the string loop that holds the bottom of the upper peg to the lower peg is eliminated).

Instead, the upper peg is held in place by means of a notch cut into the lower peg.

It's a little hard to see in the photos...



Trigger constructed by [Rob Bicevskis](#)



Trigger constructed by [Rob Bicevskis](#)

In this trigger variation, a thin horizontal stick can be used to hold the bait. Any movement of this stick will cause the upper peg to flip out, thus triggering the trap

Split Stick Deadfall Trigger

A Split Stick Deadfall is similar to the [Bait Stick Deadfall](#). Both have very sensitive trigger mechanisms.

Basically, a Split Stick Deadfall depends on a stick that has been cut in two pieces, resting end-to-end

vertically, with a smaller bait stick stuck in between the two pieces of the vertical stick.



Trap constructed by Walter Muma

Here is an overview of a Split Stick Deadfall set.

The base of the lower vertical stick is supposed to sit on a rock. To increase this trap's sensitivity, a rounded rock can be used.

This is a very tough trap to set up. The two vertical sticks are always wanting to flip out on you.

Again, the vertical stick in this trap has actually been cut into two pieces, and they are resting end-to-end, vertically. The bait stick is a much smaller stick that has been inserted into a notch cut into each end of the two vertical sticks where they meet.

The slightest movement of the bait stick will trigger this trap. If the bait stick is pushed to one side, it destabilizes the mechanism, causing the two vertical sticks to flip out.



This is a close-up of how the bait stick fits into a notch between the two end-to-end vertical sticks. The notch can be square, as in this case, or rounded.

Trap constructed by Murray Yazer



A side view of the meeting of the two vertical sticks, showing the bait stick going through the notch between them.

Trap constructed by Walter Muma

Bait Stick Deadfall Trigger

A Bait Stick Deadfall is similar to the Split Stick Deadfall Trigger. Both are very sensitive trigger mechanisms. It is also tricky to set up.



Trap constructed by Walter Muma.

Here's a picture of a bait stick deadfall set up.

The Bait Stick is the horizontal stick. The bait is placed on the end of it.

Note that the Bait Stick is larger than it might usually be in a real trap, in order to illustrate the technique and construction of this trap.

The base of the trigger mechanism is placed on a rounded stone so that the

whole thing
will collapse
more readily
when
triggered.

The stone in
this pic is not
very rounded.



A close-up view of the
trigger mechanism.

The vertical stick that
holds up the deadfall is
pointed at the end. This
aids in rapid triggering of
the trap.

The surfaces of the bait
stick have, in this case,
been leveled out. This
provides a more stable
surface for the vertical
stick to rest on.

To make this trigger more
sensitive, the bait stick
could be left rounded, and
one could select a more
rounded rock.

Trap constructed by Walter Muma.

Paiute Trap

Joseph Longshore II

Paiute trap trigger.

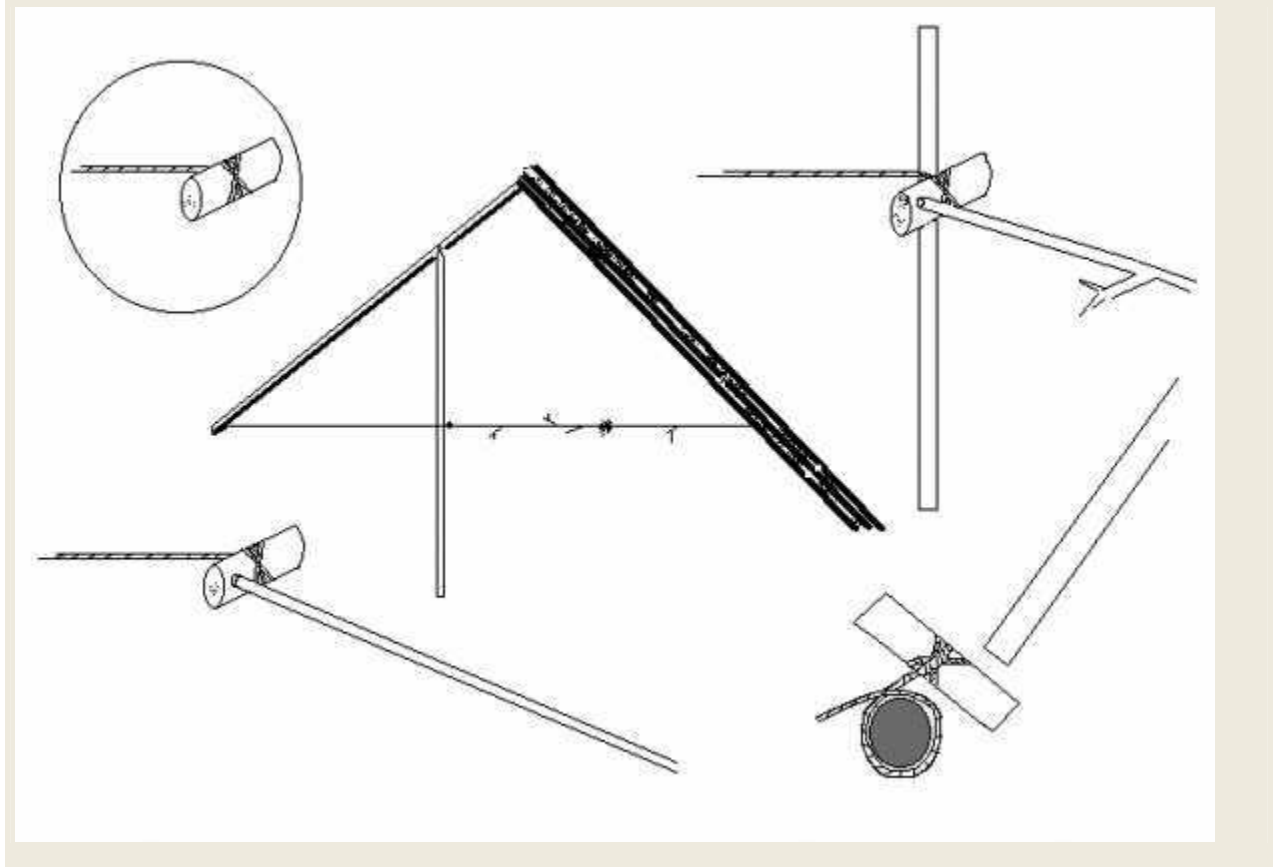

Paiute Spring Stick

This trap is based on the Paiute Deadfall. It relies on spring tension rather than the weight of a deadfall.



Trap constructed by Rob Bicevskis

Here is an overview of this trap.

The heavy weight of the Paiute Deadfall has been replaced with a stick under spring tension. In this photo this is the right-hand diagonal stick.

The spring stick has a mini-spear point carved from the stub of a branch. Thus when the trap is sprung, this will impale the animal, hopefully killing it very quickly.



Trap constructed by Rob Bicevskis

Paiute Deadfall Trap

The Paiute is a very quick trigger mechanism. It is also fairly easy to set. Unlike the Figure-4 trigger, it uses cordage. Examine the photos carefully and you will get an idea of how this trigger works.

The bait is placed on a long thin horizontal bait stick. This bait stick is held at both ends by friction. When the bait stick is moved, it slips off of the short trigger stick that the cordage is tied to (wrapped around the vertical stick). This allows the weight to fall. Be careful to place the deadfall so that it does not land on the vertical stick.

It is advisable to place the vertical stick on a flat stone. This will allow the vertical stick to fall out of the way as the weight falls (in the photo below, it will fall to the left).



Here is an overview shot of a paiute trap, showing overall positioning.

Trap and photo by Allan "Bow" Beauchamp



Here's a clear photo of a Paiute deadfall trap.

In this case the horizontal trigger stick is being held in place by a small short stick that has been stuck in the ground.

Note the "V" point at the top of the vertical stick, fitting into the notch on the underside of the diagonal stick.

Trap constructed by Rob Bicevskis



Another Paiute trap

Trap constructed by Julie Liptak.



Trap constructed by Alex Harwood.

Watch yer nose!

This type requires a knife to cut a notch on the diagonal stick and a point on the upright stick.

However, the string has less tendency to slip upwards.



Trap constructed by Walter Muma.

The Paiute deadfall trap is, in some respects, much easier to set than the Figure-4 deadfall.

Click on the small photo to watch a movie of this trap being triggered



Windows Media format (WMV)
320x240, 223 KB



Trap constructed by Walter Muma.

The one drawback of this type of trap, in comparison with the Figure-4 deadfall, is that it does require some cordage. However, the cordage doesn't have to be very strong. Therefore some elementary cordage could be whipped up from available plants without much trouble.

Note that this wouldn't necessarily be a very practical trap as it is set up here -- this is just for demonstration purposes.

Here, the deadfall rock is too high off the ground to properly trap an animal. Usually the deadfall is positioned so that it will fall flat onto another hard surface.



Trap constructed by Walter Muma.

Closeup view of the Paiute trigger.



Trap constructed by Walter Muma.

It works: dinner! :)

Here is a variation in which the diagonal is supported by a forked stick stuck vertically into the ground. In this case, you must be careful that this vertical stick does not prevent the deadfall from falling.

This form of the trap is unique in that it doesn't require a knife, although it still requires cordage of some sort.

Note that the horizontal stick is held in a "V" at the top of the upright stick.



Trap constructed by Peter Linke.

Click on the small photo to watch a movie of this trap being set



Windows Media format (WMV)
320x240, 1.5 MB

Please note that this short movie does not demonstrate the "proper" or "perfect" way to set this trap!

Trap constructed by Peter Linke.

Here are 2 movies of this trap being triggered
Click on the small photo to watch the movie



Windows Media format (WMV)
320x240, 198 KB



Windows Media format (WMV)
320x240, 537 KB

From the Primitive Skills Group (PSG) on the Internet (March 15, 2004)...

Figure 4 Deadfall

Joseph Longshore II

Drawings of the classic figure-4 deadfall trigger mechanism.

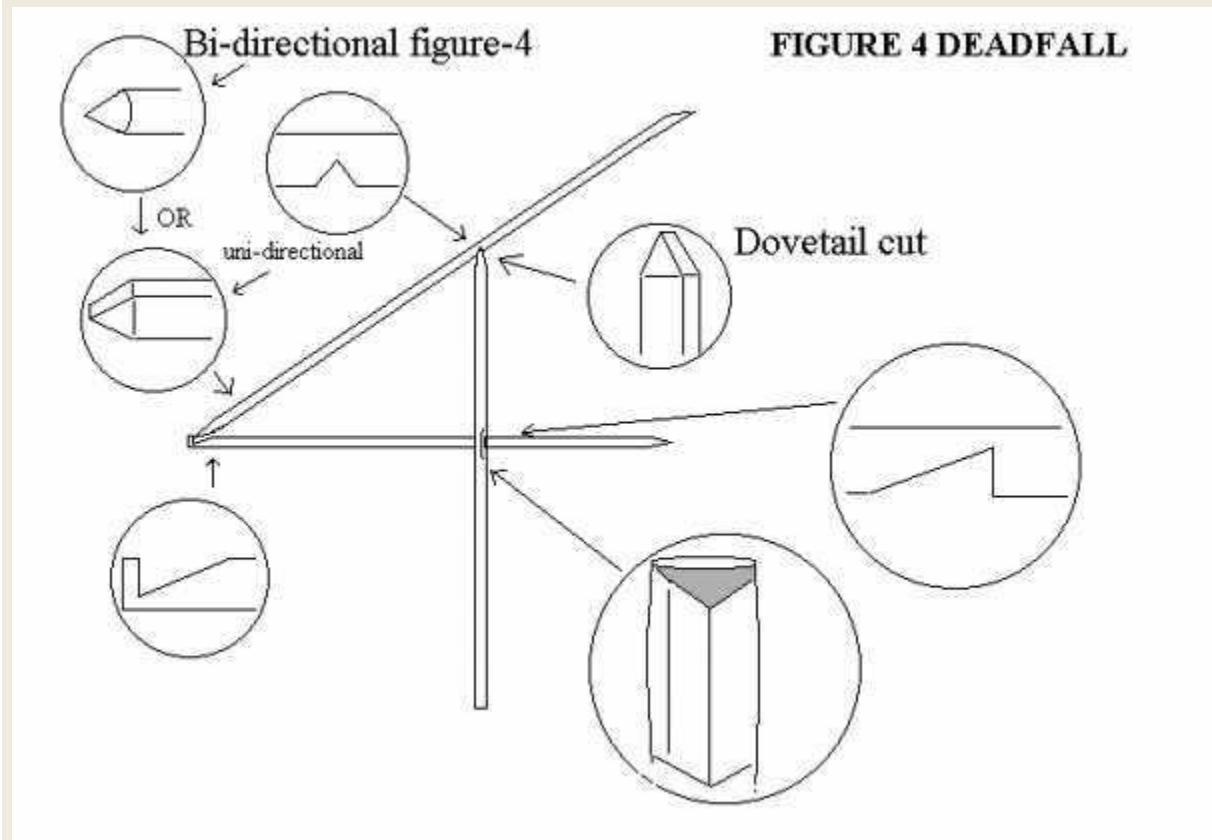

And some drawings illustrating the overall construction of a figure-4 deadfall trap, along with some options.

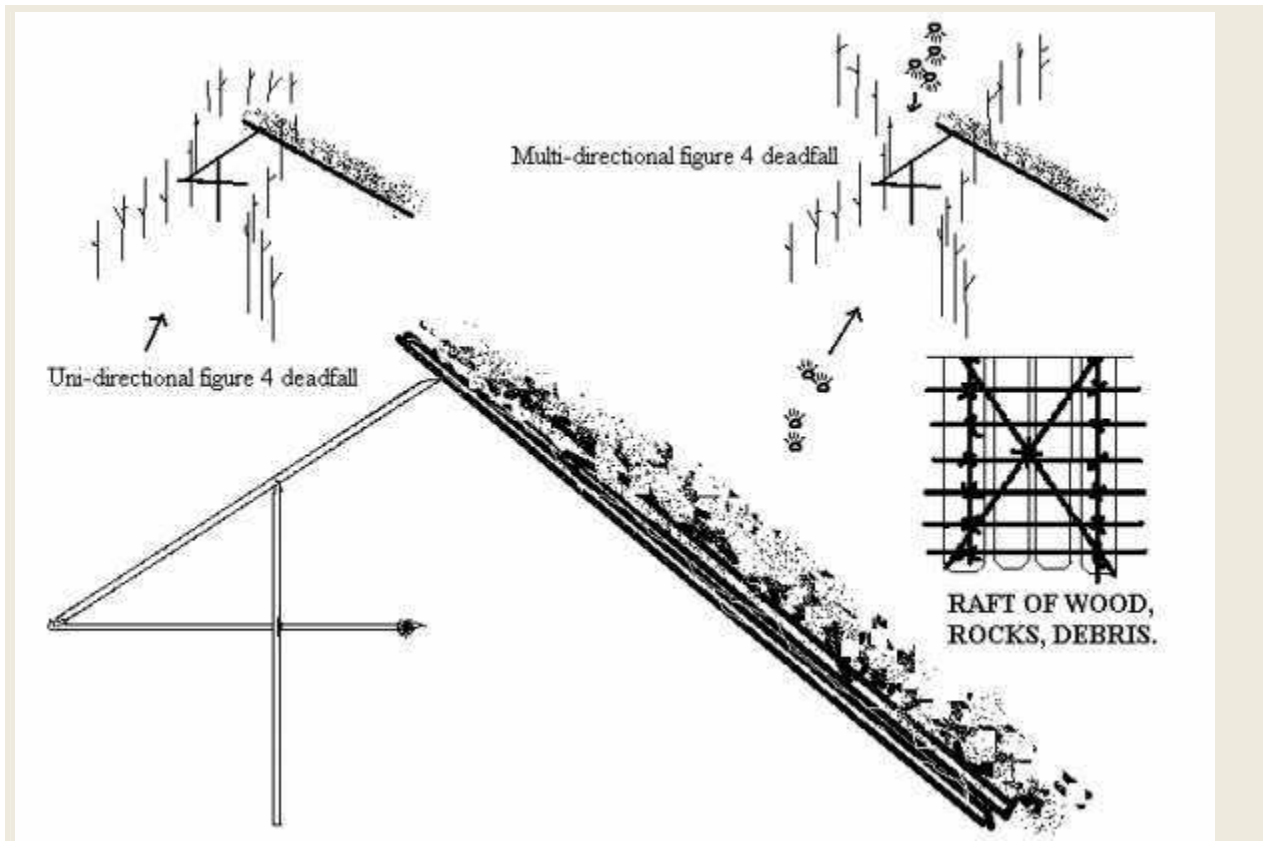

"No-knife" Figure-4 Deadfall Trigger

The typical Figure-4 trigger mechanism requires some fancy knife work to construct. Dovetails and slots must be cut into the sticks at exact angles. These angles are sometimes hard to line up.

But having constructed the trap, it seems as though a knife is essential to making it. Not so! In fact, once you've made a figure-4 trigger without a knife, it seems almost simplistic in comparison.

Here are photos of a "no-knife" Figure-4 deadfall trap.

Trap and photos by Walter Muma



An overview of the trap.

Note that the vertical stick ends in a "Y" that holds the diagonal stick.

The end of the diagonal fits into a tiny branch stub on the horizontal stick.

The horizontal bait stick is held against the vertical stick with the same kind of stub.



Detail of where the diagonal stick meets the horizontal (bait) stick.

Note that the diagonal stick is held in place with the stub of where a twig once joined the stick on the horizontal (bait) stick.



Detail of how the horizontal (bait) stick is held in place against the vertical stick.

In this photo, the bait stick is being pulled towards the right by the diagonal stick, and is held in place by the small twig that sticks out.



Detail of the "Y" at the top of the vertical stick. No fancy dovetail notch needed here!

Now, doesn't that seem much easier to construct than making one with a knife?

Of course, there are drawbacks. One has less control over how the sticks fit together. And therefore less

control over the sensitivity of the trigger.

One-Stick Figure-4 Deadfall Trigger

Here are photos and a diagram of a Figure-4 deadfall trigger made from a single stick, with a knife.

Trap by Walter Gigandet

Photos by unknown

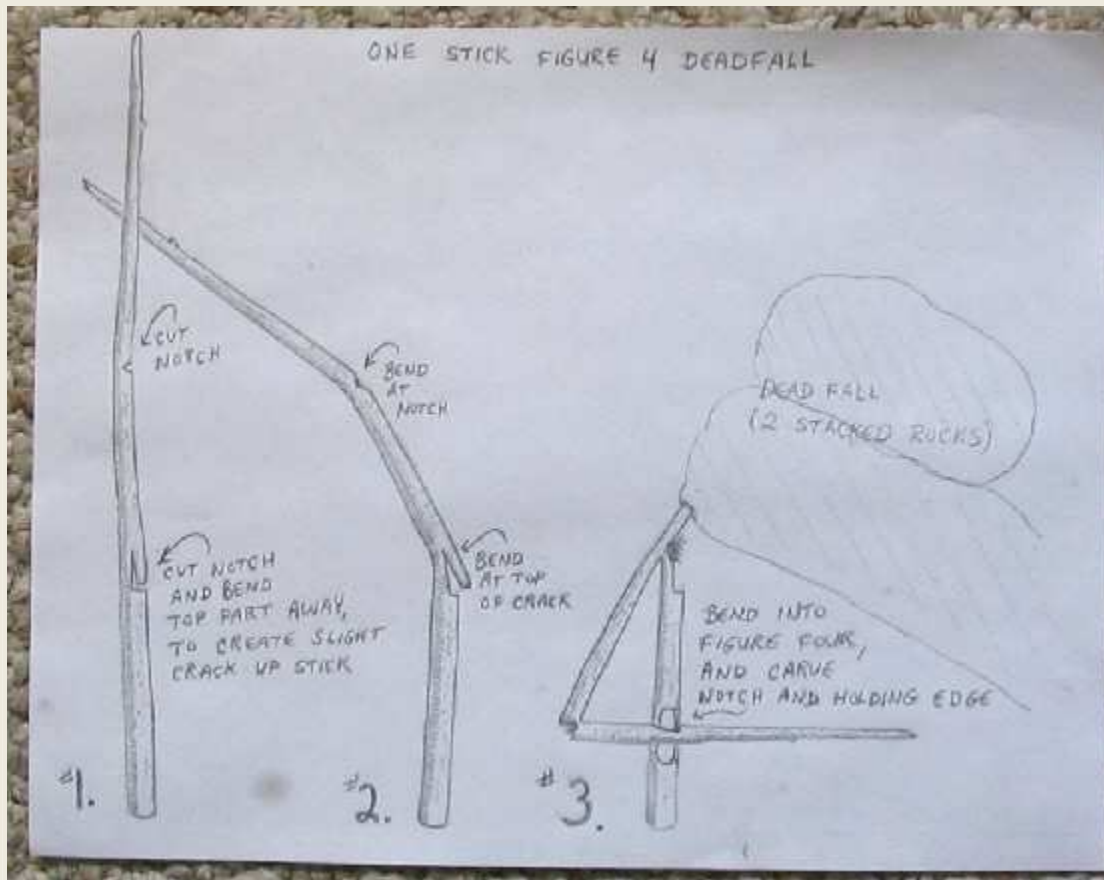

Diagram by Walt Gigandet

The stick is cut only half way thru, then snapped, but still connected at each of the corners. The upright is snapped so there is a tail attached for the deadfall to set on. The broken fibers are folded so the parts are in a figure 4, and notches are carved. This Figure-4 works exactly like a regular Figure-4 trigger, but all the pieces are attached so as to be still a single stick.

An alternate construction of this trap...



An overview of the trigger set. The deadfall in this case is a garbage can lid (for demonstration purposes only).

Note that this is slightly different than the diagram.



View of the stick, "unfolded."

Now that you have the idea of how to build a one-stick Figure-4 trigger, how about another challenge (from Walt):

Build a three stick Paiute trap, one of the sticks is the bait stick, and use no string to do

No-knife" One-Stick Figure-4 Deadfall Trigger

The typical Figure-4 trigger mechanism requires some fancy knife work to construct. Dovetails and slots must be cut into the sticks at exact angles. These angles are sometimes hard to line up. This is the appeal

of making a Figure-4 trigger without a knife.

One day I decided to take this concept a step further. I asked myself if it was possible to make a Figure-4 trigger, not only without a knife, but also from just one stick? After some reflection I hit upon a method of doing this, which is illustrated on this page.

Trap and photos by Walter Muma



An overview of the trigger.

PLEASE NOTE: this example is not necessarily an ideal one. I made it simply to show the concept.

To make this type of Figure-4 trigger, you need to use a type of wood that does not crack apart easily, one that holds together when bent. I chose a maple sapling for these reasons. Maple tends to fracture and splinter, but to hold together very well. Try breaking a maple branch in two and you'll see this effect.

In my trial run here, the hand represents the weight of a deadfall pressing down.

The bait is placed on the lower end.

I found this particular example to not be strong enough, as I had cracked the sapling at the outer edge (at the left in the photo), thus reducing the "spring" of the trigger.



Detail of the top of the trigger, where the curved part of the trigger rests on top of the upright portion.



Detail of the lower part of the trigger, where the bait portion of the trigger is held against the upright portion. The principle is the same as in the regular "no-knife" Figure-4 trigger.

An interesting experiment! This type of trigger probably has little practical value, as the materials for a multi-stick no-knife Figure-4 deadfall are probably easier to obtain. This one-stick variety requires a specific type of sapling, whereas for the multi-stick type you can utilize a variety of woods and sticks.

But it does show what possibilities there are if you let your imagination work, and break free of preconceived ideas. This type of exercise helps you to be more able to adapt to unusual circumstances

while out in the bush trying to survive.

One-Stick Figure 4

Leatha S. Warden

Here is a diagram of a one-stick figure-4 deadfall trap.

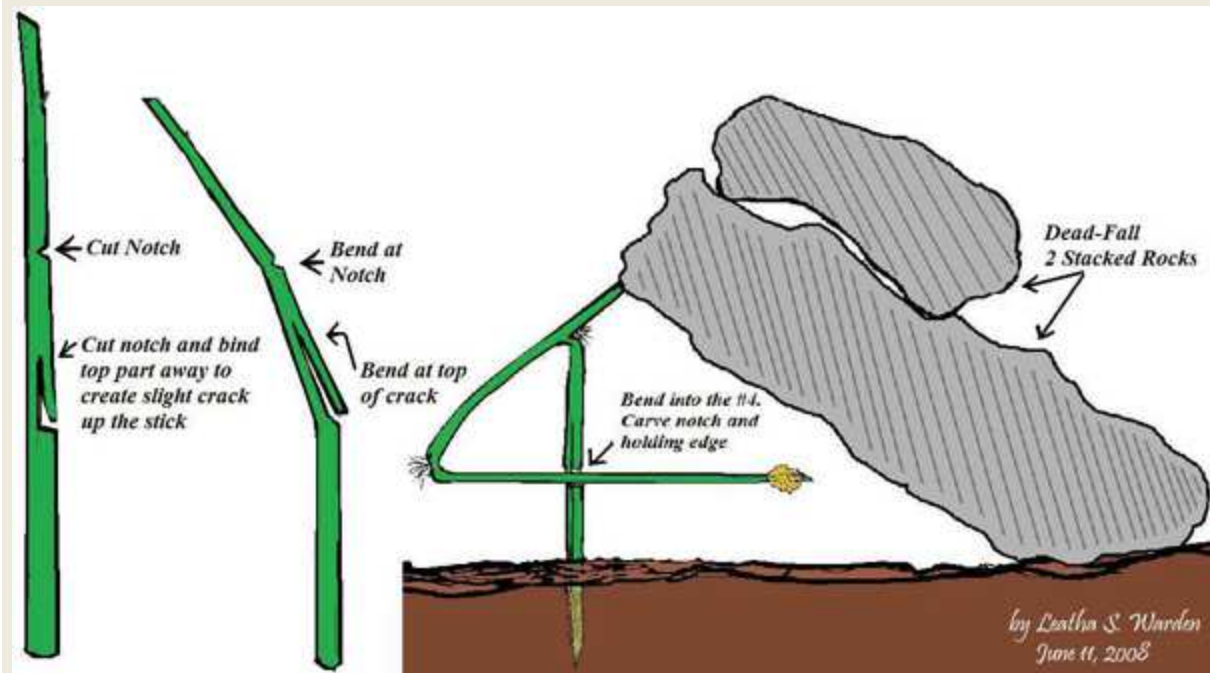

Apache Foot Hold Trap

by "Coon"

The Apache foothold trap was traditionally used to trap big game like deer. It consists of a hole, a snare and wooden stakes. Although it was intended for larger animals I have found it useful for trapping any animal such as fox, coyote and raccoon. It's a good survival trap to know due to its simplicity and adaptability to trap almost any animal.

PLEASE READ THE WARNING AT THE BOTTOM OF THIS PAGE.



Dig a hole. I dig down to about 20 inches because I like it to be deep for trapping deer. It can be slightly less deep depending on the animal you're trying to catch. It doesn't have to be very wide, just deep. Notice the water in my hole - I dug into some wet mud because I noticed deer tracks there and mud is easier to dig into. There was a lot of water in the hole but water isn't a problem, in fact it helps camouflage the hole even more. It's hard to tell exactly how deep it actually is because there's so much water in it.



Next we put in the wooden stakes. These are the top stakes. Underneath in the water is another set of wooden stakes - they look exactly the same as the top. Simply pound the stakes in the side of the hole. I use about six. I used the tracker knife to make them pointed.

The stakes should be roughly 12 inches long or more. These stakes will temporarily hold the animal making it struggle more and making the snare tighten around its leg. Although many people think the stakes are meant to hold the animal in the hole the entire time until you check the trap, I have learned from experience that they manage their way out of the stakes.



Make a snare using strong cordage. I used this white rope for demonstration purposes for these photos. Simply lay the rope on top of the first set of wooden stakes. Make sure you wrap the other end of the rope tightly around a healthy tree.

Remember the stakes only help to get the snare tight around the animal's leg - the rope is what's holding it. With that said be sure your rope is strong and your knots tight and you should be fine.



I like to snare the other end of the rope to a nearby tree as shown in this photo. When the animal tries to run it makes the snare on its leg tighter and the snare on the tree tighter. This method has never failed me even once. Keep in mind you want the deer or other animal to have some room to move around a bit, so don't make the rope too short or too long.



Here is what it should look like before you camouflage it. Simply throw tall grass and dead leaves over it enough to cover the hole also remember to cover the rope on the ground.



The hole is now camouflaged. Notice how I didn't put too much on the hole, just enough to cover it. I covered the rope later on.

Now any deer walking by will walk into the hole and as it struggles its way out of the stakes it won't realize the snare has tightened around its leg. And you will have successfully trapped a deer. Just be very cautious - the deer may be snared but it's not dead! Don't get too close and kill it quick.

How to Build a Small Game Survival Snare



Creek Stewart of [Willow Haven Outdoor](#).

I practice and learn survival skills not because I need them on a daily basis, but rather for the one day when I must use them to stay alive. Survival is the intersection between knowledge and necessity. The outcome in a survival scenario can be dramatically influenced by practicing survival skills **before** you need them. One such skill that requires thoughtful practice is ***How to Build a Small Game Survival Snare***. A primitive make-shift snare can be used to trap and kill a variety of animals for food in a survival situation. This basic concept can also be modified and used as a “man-trap” or “perimeter alarm”—both of which are commonly deployed in guerrilla warfare.

While constructing a survival snare is fairly simple, it is often oversimplified with vague instructions and limited photos. By the time you finish reading this article you will know the who, what, why, when, where, and how of the simplest and most efficient survival snare known to man. If your knowledge ever crosses paths with necessity, this may prove useful.

The Why

For short term survival (1-7 days), food is not a critical priority. Shelter, water, fire, and signaling are typically more immediate concerns. At some point, though, you must put calories on the human furnace or suffer the debilitating consequences of starvation.

To my knowledge there isn't one single primitive culture, tribe, or people where meat is/was not a critical component of their diet. Modern equipment, farming, transportation, food processing, supplements, and complex supply chains give us the option not to eat meat if we choose. Remove these luxuries for an extended period of time and the calories from meat once again become necessary for survival. It would be extremely difficult, if not impossible, to source enough calories in a primitive survival scenario by gathering wild plant edibles alone—especially in cold weather climates or seasons.

Time and energy conservation are both very important factors to consider in any survival situation. This is precisely **why** snares are such an important survival tool. Once constructed and set, a snare will allow you to focus on other survival priorities. And, it will keep working even while you are sleeping. With 10 snares you can be hunting in 10 different locations at the same time while expending ZERO energy. You become a one man hunting party. Snares are a survivor's secret weapon. Not only are snares incredibly reliable and effective, they also require very few resources to build—in materials, energy, and time.

The Who

Before you even think about spending time and energy on building and setting a snare, you must first determine whom (or in this case which animal) your snare is targeting. For survival purposes, small game represents your best chance of success. While the snare design I will show you can be scaled up to catch animals as large as deer, it is more practical to target small game animals such as rabbit, squirrel, and ground dwelling fowl such as quail or grouse. This snare can also be modified to fish for you as well. Not only are smaller game animals easier to catch and field dress, but you can set numerous small game snares with the same time and material resources it would cost you to set one larger snare. Setting snares is a numbers game. The more snares you set, the greater your odds of success.

The When and Where

This snare can be effective in virtually any climate and any environment on any continent. It can be deployed any time of the year and is equally effective day and night. From desert to rain forest, I can't think of a place where you can't use some version of it to catch small game.

With that said, placing random snares throughout the woods is foolish and a waste of time and energy. Though they can be baited to draw in animals, snares are most effective when strategically placed in-line with existing small game trails. As you will see in the HOW section of this article, the heart of this snare is a noose which should be positioned across a frequently traveled small game path or shelter entrance such as a den or burrow.

To be successful, you must read the forest or terrain in which you find yourself. You must look for signs of small game traffic and activity. These signs include scat (droppings), tracks, rubs, scratches, signs of feeding, shelter or burrow entrances, food and water sources, and well-traveled game trails.

I took a walk in the forest here at [Willow Haven Outdoor](#) and snapped a few photos of some telltale animal signs that should catch the eye of a passing survivor. See if you can identify the small game activity in these photos below:









The best place for the snare I detail in the next section is across a well-traveled small game path. These paths, called “runs,” typically lead from the nest, shelter, or den to water and food sources. Animals are the ultimate survivors and also live by the survival code of energy conservation. Consequently, several animals may travel the same trail or path on a regular basis. Animals travel the path of least resistance and strategically placed snares along this path can be very effective.

Finally...The What and the How

There are literally hundreds of different snare sets and designs—some of which are overly complex. If you only learn one snare design in your life, it should be what I call the Trigger Spring Snare. I wish I could take credit for the design, but it dates back to the beginning of mankind and versions of it have been used by primitive people in all parts of the world. It has been time-tested, field-tested and survival-tested. It is my #1 GO-TO Survival Snare set.

The Trigger Spring Snare consists of 4 components which can be readily sourced in nearly any survival situation. These components are:

1. The Noose (made from some kind of cordage—preferably wire)
2. The 2 Part Trigger (carved from wood)
3. The Leader Line (also made from some kind of cordage)
4. The Engine (typically a bent over sapling)

The Noose

The noose does exactly what you think—it nooses the animal. The most effective noose material is wire. There are many different types of wire that will work. The wire must be flexible. It cannot be too thick or brittle. When set in the shape of a noose (shown later), it must tighten easily and quickly when pulled upon. Some examples are:

- Twisted copper strands from the inside of an everyday lamp or small appliance power cord
- Picture hanging wire
- Stripped wire from car or vehicle electrical systems
- Craft wire
- Headphone wire
- Wire from a spiral bound note pad
- An uncoiled spring (such as in a ballpoint click pen)
- Wire reinforced bras
- Wire from inside electronics such as toys, phones, and radios

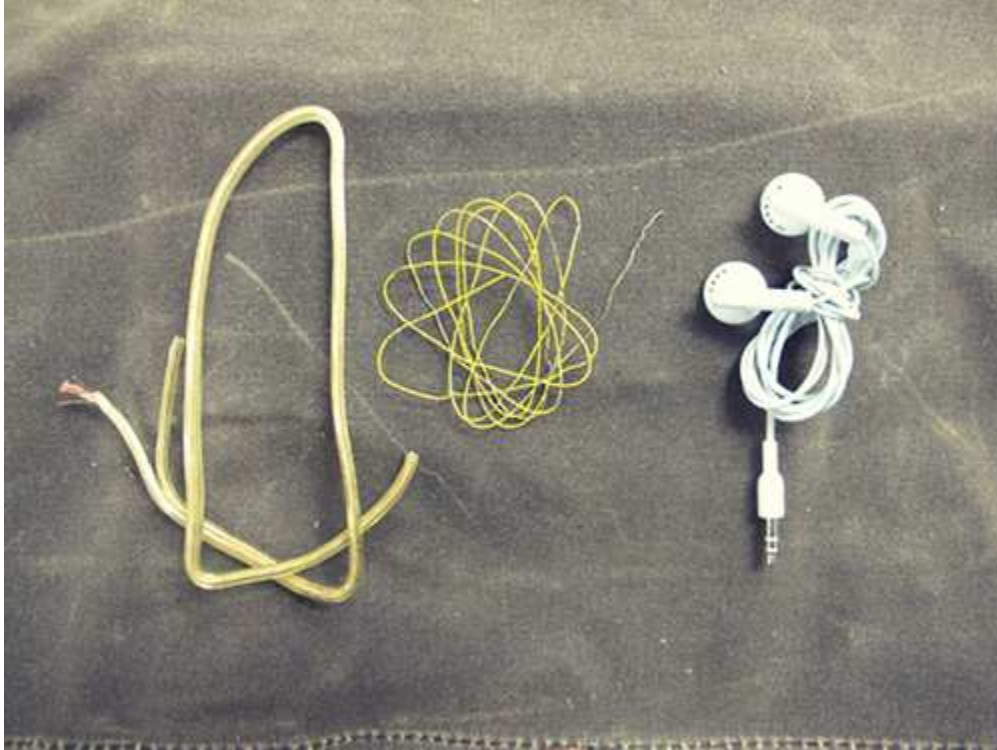

If wire is unavailable, some kind of string or cord will have to do. It must be strong enough to hold a 5-8 lb animal. If it snaps under the force of a couple jerks between your fists then it probably won't work well.



Here are several alternative cordage ideas:

- The inner strands from 550 Parachute Cord
- Shoe strings
- Dental floss
- Fishing line
- Unwoven webbing
- Strong stitching material such as what is used to sew together leather and outdoor goods such as purses, wallets, cell phone cases, belts, jackets, and backpacks

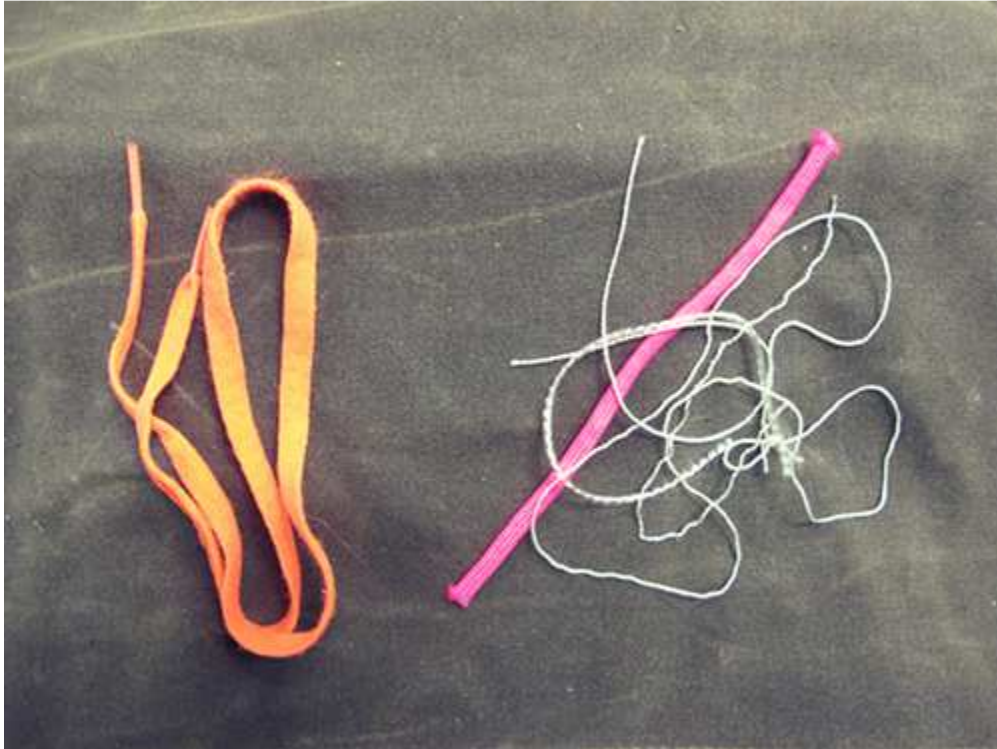

If no modern wire or cordage is available, there are many natural plants and tree bark fibers that can be fashioned into suitable cordage. Several excellent cordage plants/trees are:

- Milkweed
- Dogbane
- Stinging nettle
- Many inner tree barks such as cedar and elm
- Palm
- Cattail

Below is a photo of several cords made from reverse wrapping plant and tree bark fibers. Remember, primitive cultures used this snare for hundreds of years with no modern wire or rope. It takes more time and knowledge but is certainly possible.



The average length of your noose cord needs to be 18-24 inches for most small game animals. To construct your noose you need to make a small loop in one end about the diameter of a pencil. With wire you can simple make the loop and twist the wire back on itself several times.

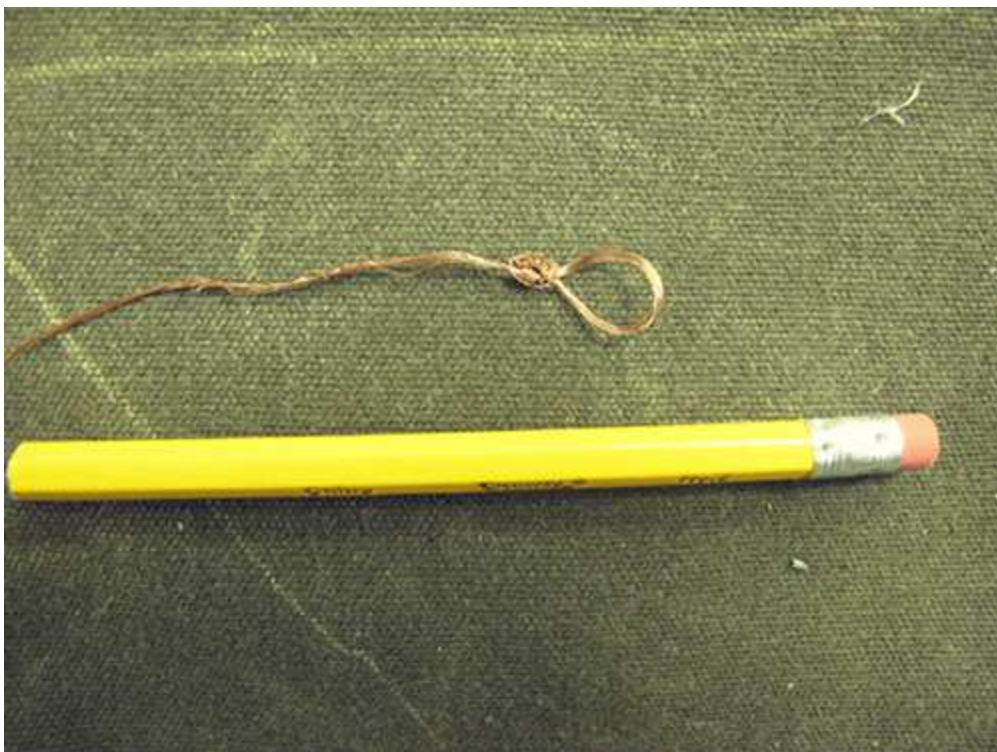

With string, simply fold the end back onto itself and tie an overhand knot to secure the loop.

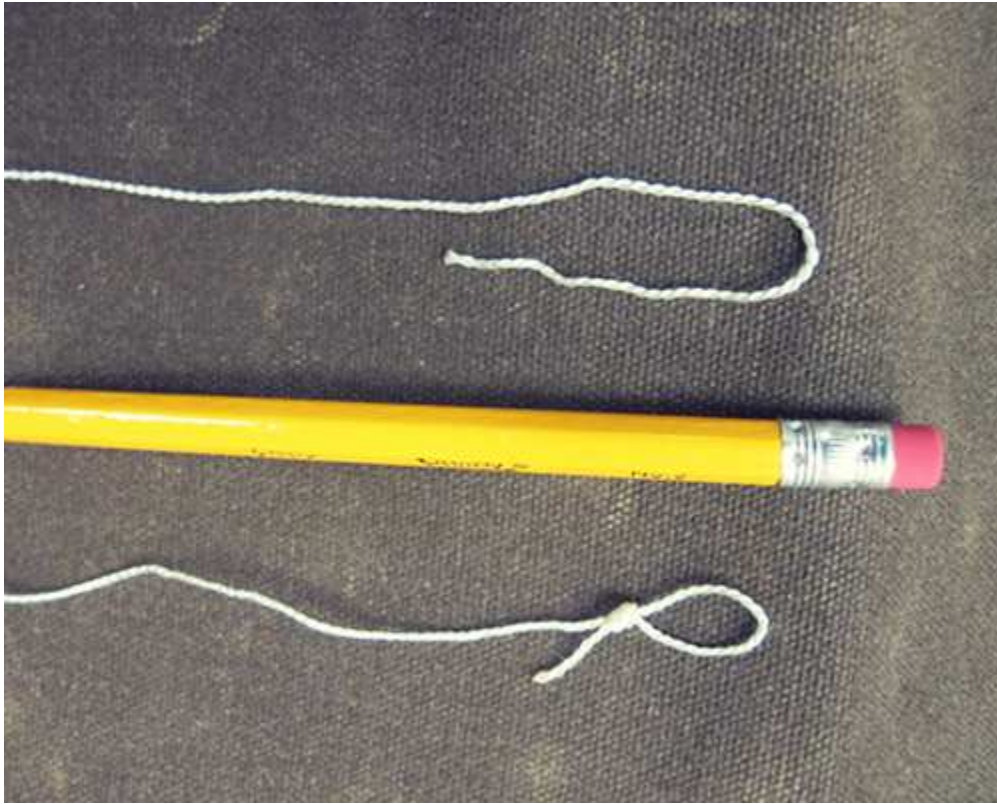

Then, run the other end of the cord/wire through the loop to create your noose. The tag end is then tied to your trigger as is detailed in the next section.

The Trigger and Leader Line

The trigger consists of 2 parts: the HOOK and the BASE. As you can see in the diagram below, the LEADER LINE is tied to the top of the HOOK and the NOOSE is tied to the bottom of the HOOK. The ENGINE (typically a bent over sapling) provides tension to the HOOK which is secured under the BASE—until an animal disengages it by pulling on the NOOSE. The LEADER LINE from the HOOK to the ENGINE can be any type of cordage. It needs to be strong enough to withstand the initial “spring jerk” and then the weight of the suspended (and struggling) animal.

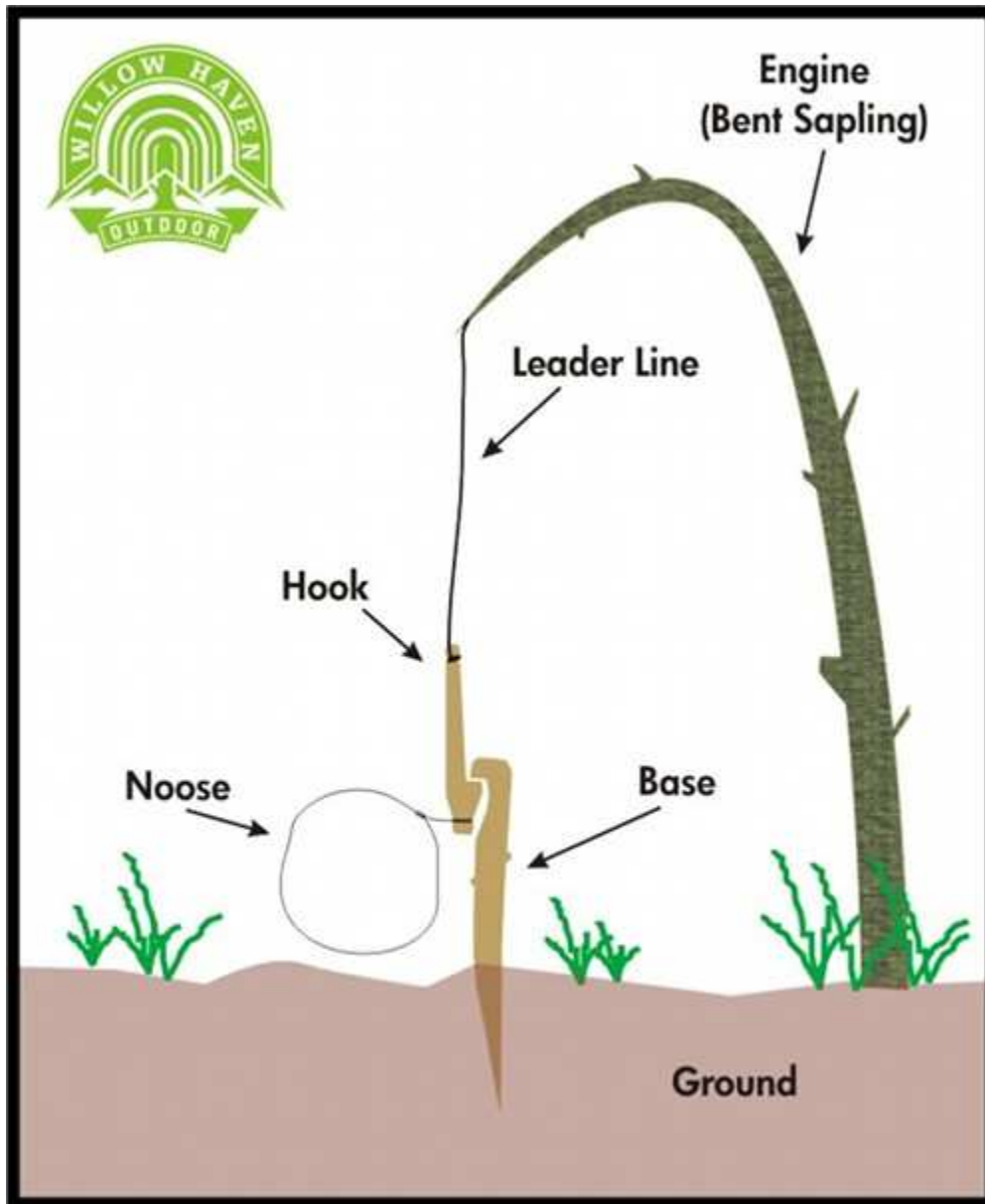

Several Trigger Modifications

When it comes to this style of trigger, don't limit yourself to one exact model. The same result can be accomplished in many similar ways. You may have to improvise in a survival scenario. It is the ***principle*** that is important. Below are several trigger modifications that I worked up to give you a few ideas.

CARVED TRIGGER



This trigger style is simply carved from 2 hard wood sticks. Notice the BASE of the trigger system that is staked into the ground. The noose in the photo above is made from the inner strands of 550 paracord. Below is another photo of a carved trigger snare. This noose is made from the copper wires from inside an old lamp cord which makes an ideal noose material. Notice how I've used little twigs to hold my noose in place. This can be helpful to keep your noose exactly where you want it.

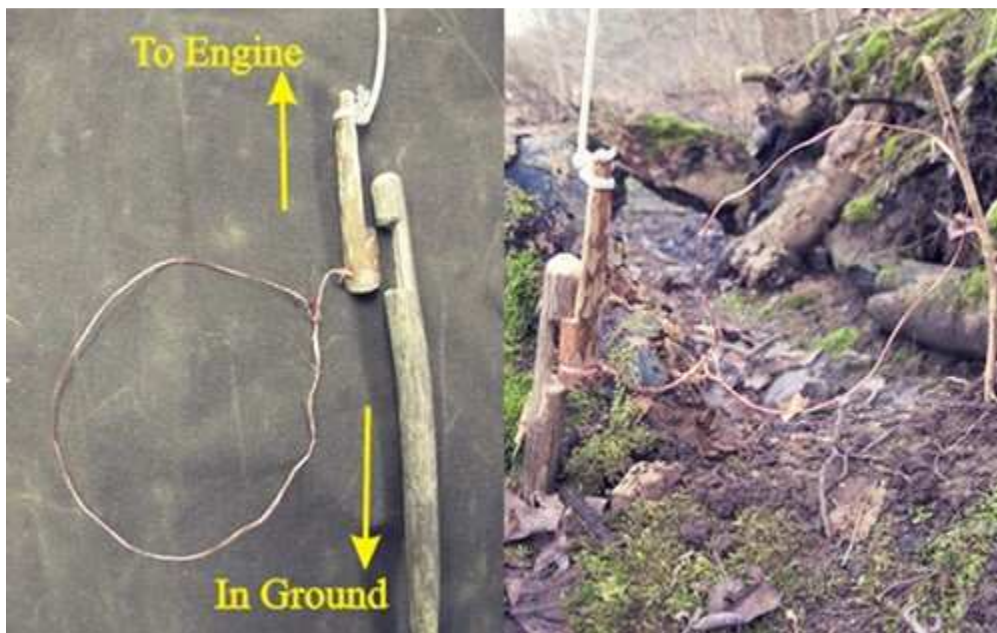

PRIMITIVE "Y" STICK TRIGGER

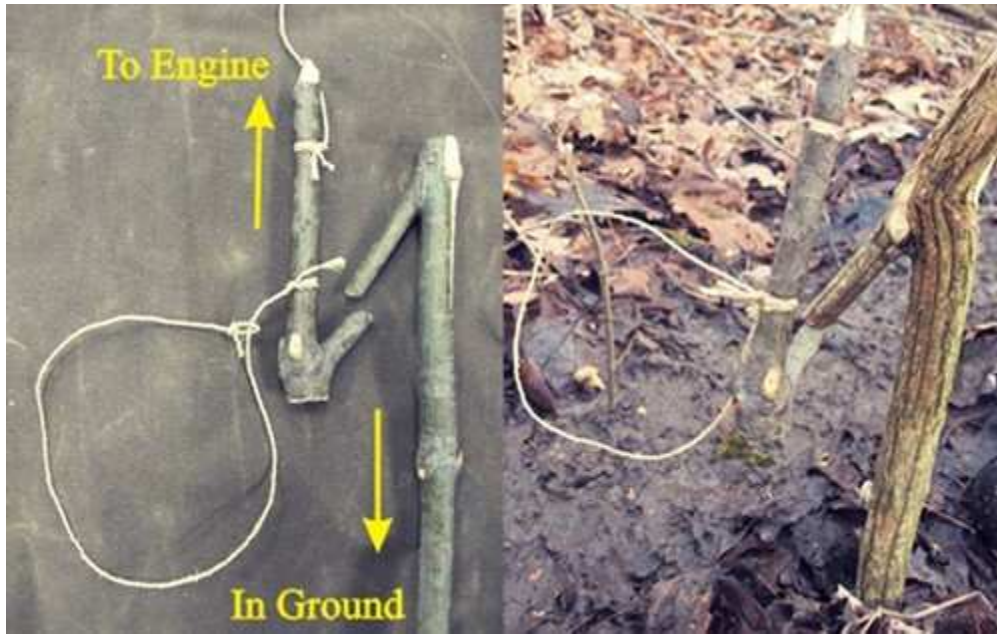

This trigger requires very little carving— simply find 2 sticks that branch how you need them and let nature provide your trigger system. The noose in this photo is made from the fibers of a raffia palm tree. This BASE is also staked into the ground.

PEG STYLE TRIGGER

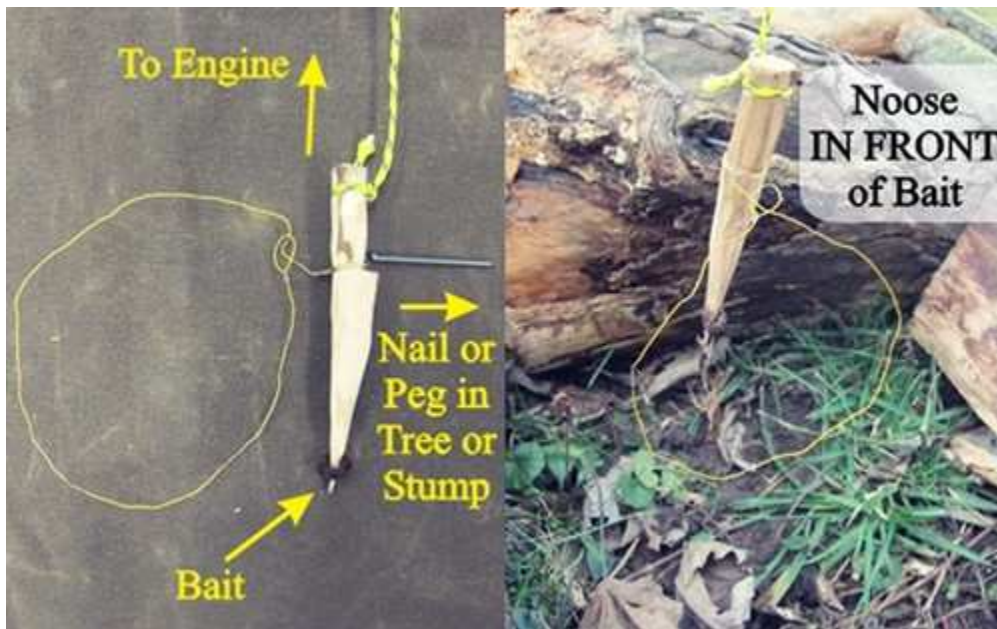

Rather than having a BASE that is staked in the ground, the HOOK of this trigger system is secured on a peg or nail that you can place in a nearby log, stump, or tree. I've even created triggers that have hooked onto nearby rock ledges. This photo also features a "baited trigger." I have sharpened the bottom of the hook and stuck on a piece of bait (raisin) to lure an animal through the noose. As soon as the bait is tampered with, the HOOK disengages. Make sure the animal must put its head through the noose to access a baited trigger.

Fishing Modification

This same trigger snare principle can be used with a hook and line for fishing as well. Instead of using a noose, attach your fishing line to the bottom of the HOOK TRIGGER. When a fish pulls your line and disengages the trigger, the ENGINE will pull and set the hook in the fish's mouth. Make sure your TRIGGER HOOK is just barely set so that the slightest tug from a nibbling fish engages the ENGINE. See the diagram below:

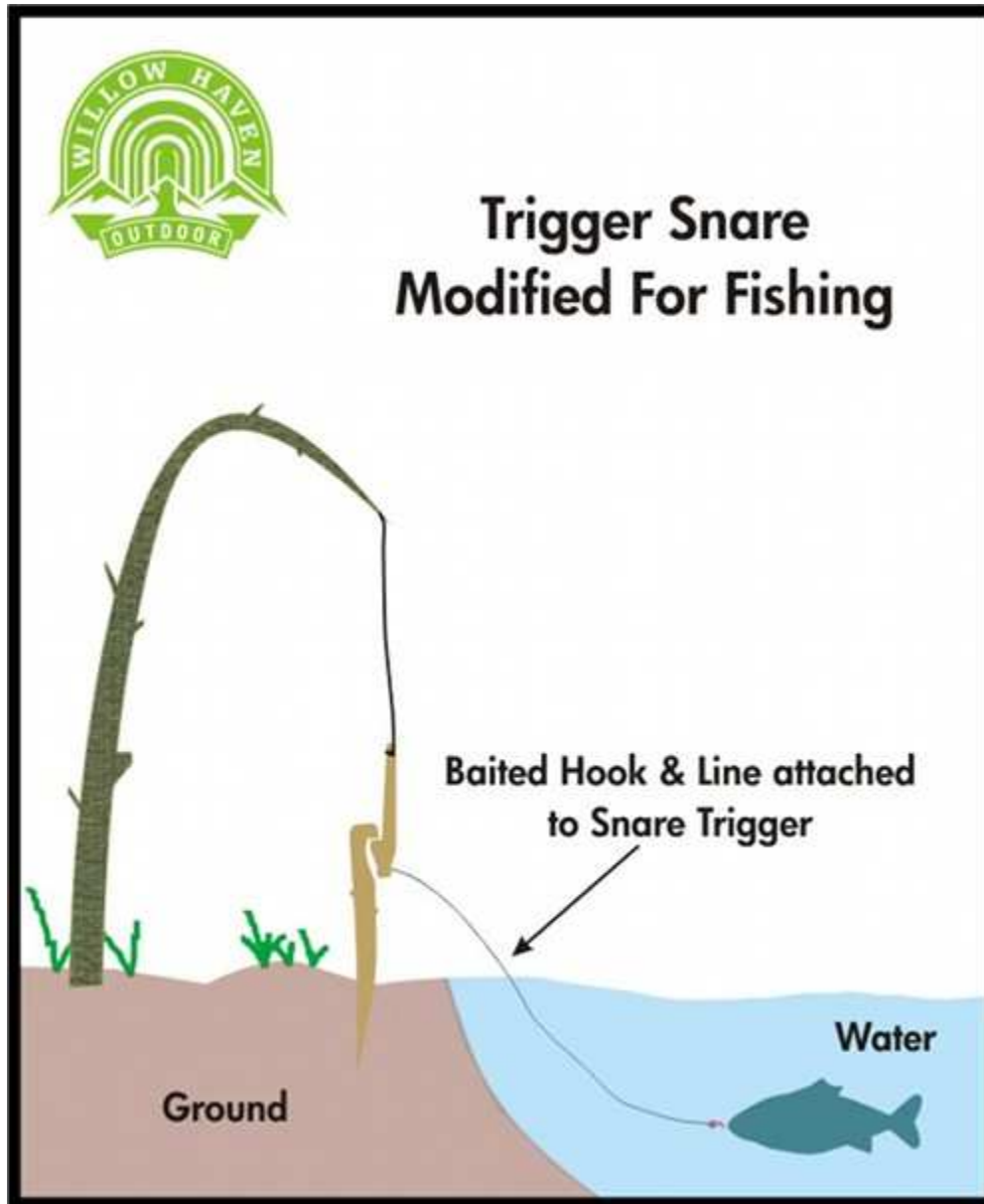

The Engine

Every environment is different and unique. There may not be a sapling to bend over along a game trail. Or, you may be in the middle of a prairie or field where there are no trees at all. If so, you must improvise. There are many ways to do this. One way is to simply cut down a green sapling or branch from another area and stake it in the ground to use as an ENGINE. Your LEADER LINE can also be weighted and run over a branch or make-shift tripod to serve the same purpose. In the photo below I've weighted the LEADER LINE with a 10 pound rock that applies tension to the TRIGGER. I used the bark from a root as the LEADER LINE and a NOOSE made from braided cattail leaves—this is a 100% primitive snare set.



In the set below, I used a similar principle except I erected a make-shift tripod to serve as an anchor point for the LEADER LINE. Here, the LEADER LINE is a high visibility 550 Paracord.



Your ENGINE (whether a sapling, branch, or weighted system) should be powerful enough to suspend a small game animal in the air. This helps to ensure a faster and more humane kill and also keeps your catch away from other predators who would certainly be very interested in a free meal. If in doubt, you can test your snare ENGINE by using a 6-8 pound rock or log.

A NOTE ABOUT TIME AND ENERGY CONSERVATION:

The NOOSE from this snare system can be an incredibly effective snare by itself—without a TRIGGER or ENGINE. By securing the tag end of the NOOSE to a stake or tree and placing it across a burrow/nest entrance or a very well-traveled small game run, a trigger system may not even be necessary. This is a

very popular method for snaring rabbits. It doesn't get easier than this. Be prepared, though, for a live animal once you return in many cases. See the diagram below.

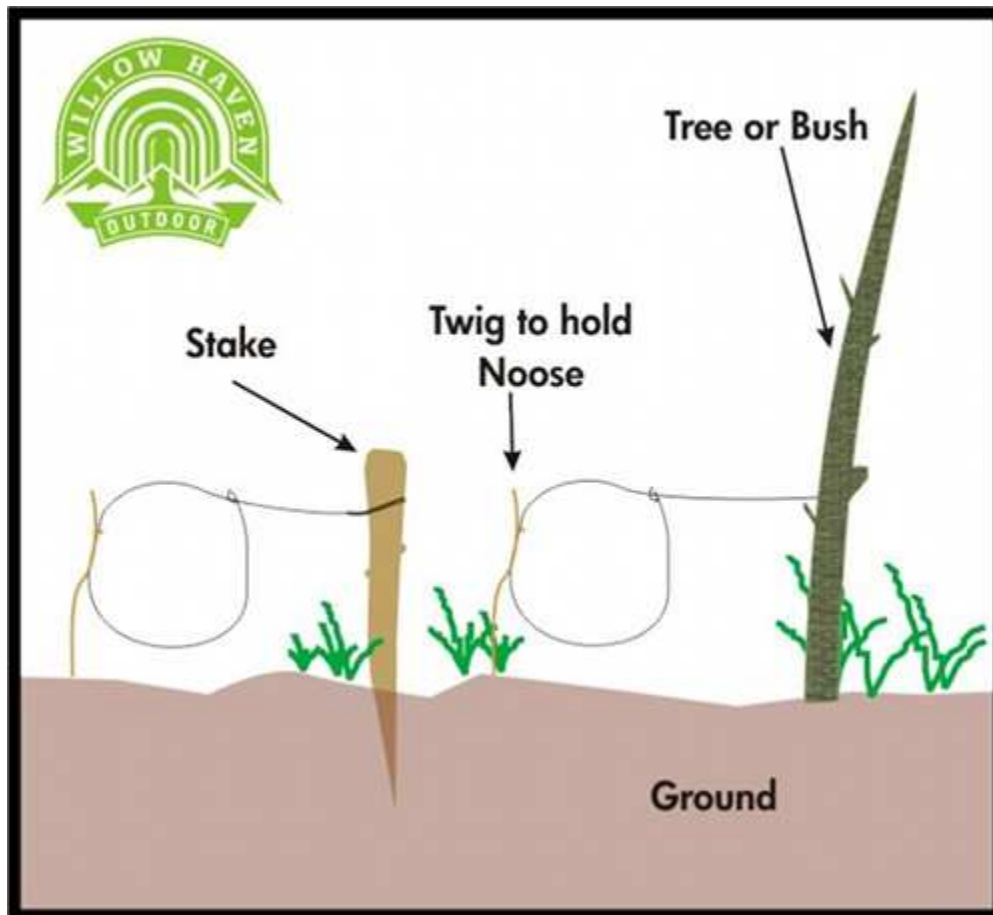

Directing the Traffic Flow

As I mentioned earlier, animals will typically follow the path of least resistance to conserve energy. Use this to your advantage by arranging sticks, logs, dirt, rocks, or other objects in such a way that funnels the animal into your snare NOOSE.

Try not to disturb the area too much if possible. The more natural you leave it the better. Animals survive on INSTINCT and will react if something seems out of place. The forest is their home and they know it by heart. Leave as little trace of your activity as possible.

Conclusion

I'll end this article with a list of *Survival Snaring Guidelines* that I follow and for you to consider.

- Survival snares are for survival situations. Primitive improvised snares are otherwise illegal.
- The more snares you set, the greater your chances of success.
- If moving from an area, disable all snares you've set.
- Check your snare sets several times each day if possible—especially in warm weather. Your catch can spoil or be scavenged by other predators. And, if you have a live animal, you don't want it to suffer longer than it has to.

- If you kill it, eat it. A diseased animal is the exception.
- Remains from previously snared animals make excellent bait for other snares—especially entrails.
- Meat is not the only survival resource that can be gained from snaring an animal. The hide can be used. Most animals have enough brains to brain-tan their own hide. Bones can be used as tools, hooks, and spear points. Intestines, sinew, and rawhide can be used for lashings and cordage. Use as much of the animal as possible. It has given its life for you.